



English

VISION:mini™
29mm cubic UXGA
High-Speed B/W CMOS PoCL Camera

VCC-GC20U11PCL

Product Specification
& Operational Manual

CIS Corporation

Table of Contents

	PAGE
1. Scope of Application	3
2. Handling Precautions	3
3. Notes on Partial Scan Mode Operation	5
4. Product Outline	5
5. Specification	6
5.1. General Specification	6
5.2. Camera Output Signal Specification	8
5.3. CMOS Spectral Response (Representative value)	9
5.4. Video Output Format	9
5.5. Camera Link Port Data Bit Assignment (Base Configuration)	10
6. Function Settings	11
7. External Connector Pin Assignment	13
7.1. 26pins Mini Camera Link Connector 12226-1100-00 PL (SUMITOMO 3M)	13
8. Timing Chart	14
8.1. Horizontal Synchronous Signal Timing	14
8.2. Vertical Synchronous Signal Timing	14
8.2.1 Full Frame Scan Mode	14
8.2.2 Fixed Trigger Shutter Mode	15
8.2.3 Pulse Width Trigger Shutter Mode	16
9. Partial Scan Mode	17
9.1. Horizontal Partial Scan	17
9.2. Vertical Partial Scan	18
10. Remote Interface Function	19
11. Initial Settings	20
12. CMOS Optical Axis Accuracy	21
13. Dimensions	22
14. Cases for Indemnity (Limited Warranty)	23
15. Sensor Pixel Defect	23
16. Product Support	23

1. Scope of Application

This is to describe VCC-GC20U11PCL, high-speed B/W CMOS Camera. All specifications contained herein are subject to change without prior notice. Reproduction in whole or in part is prohibited.

2. Handling Precautions

The camera must not be used for any nuclear equipments or aerospace equipments with which mechanical failure or malfunction could result in serious bodily injury or loss of human life. Our warranty does not apply to damages or defects caused by irregular and/or abnormal use of the product.

Please observe all warnings and cautions stated below.

Our warranty does not apply to damages or malfunctions caused by neglecting these precautions.

- Do not use or store the camera in the following extreme conditions:
 - Extremely dusty or humid places.
 - Extremely hot or cold places (operating temperature -5°C to $+45^{\circ}\text{C}$)
 - Close to generators of powerful electromagnetic radiation such as radio or TV transmitters.
 - Places subject to fluorescent light reflections.
 - Places subject to unstable (flickering, etc.) lighting conditions.
 - Places subject to strong vibration.
- Remove dust or dirt on the surface of the lens with a blower.
- Do not apply excessive force or static electricity that could damage the camera.
- Do not shoot direct images that are extremely bright (e.g., light source, sun, etc.), and when camera is not in use, put the lens cap on.
- Follow the instructions typeapter 7, "External connector pin assignment" for connecting the camera. Improper connection may cause damages not only to the camera but also to the connected devices.
- Confirm the mutual ground potential carefully and then connect the camera to monitors or computers. AC leaks from the connected devices may cause damages or destroy the camera.
- Do not apply excessive voltage. (Use only the specified voltage.) Unstable or improper power supply voltage may cause damages or malfunction of the camera.

- The voltage ripple of camera power DC +12V \pm 10% shall be within \pm 50mV. Improper power supply voltage may cause noises on the video signals.
- The rising time of camera power supply voltage shall be less than +10V, Max 60ms. Please avoid noises like chattering when rising.

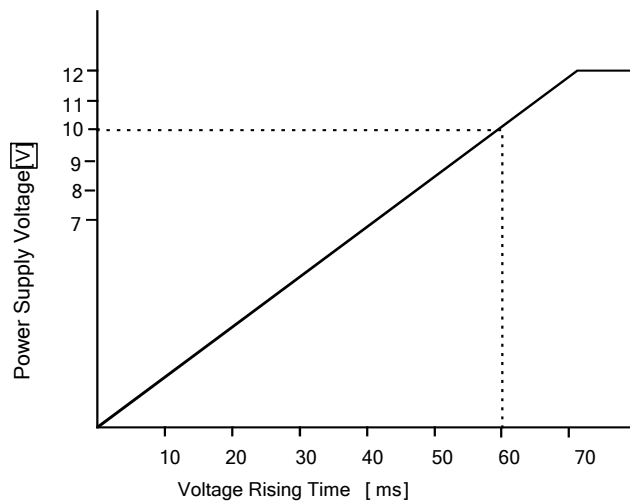

In case of abnormal operation, contact the distributor from whom you purchased the product.

3. Notes on Partial Scan Mode Operation

At vertical partial scan mode, the smaller the set reading out lines, the faster the camera exposure and output operation will be. And, at the same time, power consumption will be increased. Power consumption when the minimum partial scan line number is set will be approx. 2.6W, while it will be approx. 1.7W at full frame scan. That is about 1.5 times higher. With higher power consumption, heat will be increased as well.

We recommend promoting heat dissipation when installing our camera to your system, especially when reading out line is set between the ranges of 50lines to 1line.

For instance, installing the camera to the place under 40 degrees C ambient temperature, or installing the camera to a metallic part, would be effective.

4. Product Outline

VCC-GC20U11PCL is an industrial B/W high-speed digital video camera module utilizing a global shutter type, 2/3 type 2M pixels CMOS sensor. Interface of VCC-GC20U11PCL complies with power over camera link (Base Configuration) with its resolution 2.2M pixels. Entire pixels can be read out within approx. 1/70s.

Key Features

- High frame rate, 70.73fps, at full frame scan mode with Camera Link Base Configuration.

$$\begin{aligned} \text{Frame rate} &= (\text{pixel clock}) / (((\text{horizontal output pixels/output tap number}) \\ &+ \text{Horizontal Blanking}) \times (\text{Vertical Output Lines} + \text{Vertical Blanking})) \\ &= (79.99\text{MHz}) / (((2050/2) + 5) \times (1088 + 10)) \\ &= 70.73\text{fps} \end{aligned}$$

- 29mm cubic in size (excluding projection).
- PoCL 2Tap output (Base Configuration)
- 8bit / 10bit selectable
- External Trigger
- Shutter Speed: 1/70s ~1/50,000s
- Fixed Trigger Shutter Mode
- Pulse Width Trigger Shutter Mode
- Partial Scan Mode (Horizontal and Vertical)
- Free sample control software for evaluation purpose only is downloadable via our web.

5. Specification

5.1. General Specification

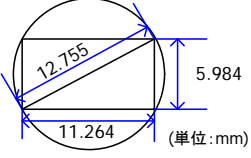
Item	Specification	
(1) Pickup Device	Device Type	B/W CMOS
	Effective Pixel Number	2048(H) × 1088(V)
	Unit Cell Size	5.50 μm(H) × 5.50 μm(V)
	Chip Size	11.264mm(H) × 5.984mm(V) (2048 × 5.5 μm(H) × 1088 × 5.5 μm(V))
	Image Circle	φ 12.755mm 
(2) Video output frequency	Pixel Clock	79.99 MHz
	Horizontal Frequency	Full Frame Scan Mode: 77.66kHz Pixel clock: 1030CLK
		Partial Scan Mode (Horizontal 1/2): 155.32kHz Pixel clock: 515CLK
	Vertical Frequency	Full Frame Scan Mode: 70.73kHz Scanning Lines: 1098H
Partial Scan Mode (Vertical 1/2): 280.36kHz Scanning Lines: 554H		
(3) Sync. system	Internal Sync. System	
(4) Video output standard	PoCL 2Tap Output (Base Configuration)	
(5) Resolution	1088 TV lines equivalent (VGA size)	
(6) Output Format	8bit/10bit selectable	
(7) Sensitivity	F5.6 400lx (Shutter Speed: 1/70s, Gain 0dB)	
(8) Minimum illumination	F1.4 1.5lx (Shutter Speed: 1/70s, Gain +12dB)	
(9) Dust or stains in optical system	No dust or stain shall be detected on the testing screen with setting the camera aperture at F16.	
(10) Power requirements	DC+12V±10% (Max voltage shall not be exceeded +15V)	
(11) Power consumption	Approx. 1.7W at full frame scan (DC+12V IN). Approx. 2.6W at partial scan with minimum line number setting (DC+12V IN).	
(12) Dimension	Refer to overall dimension drawing (Clause 12) H:29mm W:29mm D:29mm (excluding projection)	
(13) Mass	Approx. 50g	
(14) Lens mount	C mount (Refer to overall dimension drawing)	
(15) Optical axis accuracy	Refer to drawing for CMOS Optical Axis Accuracy (Clause 11)	
(16) Gain variable range	0~+12dB (Digital Gain:+0.1dB/step)	
(17) Gamma	1(Fixed)	
(18) Shutter speed variable range	OFF(1/70), 1/500s, 1/750s, 1/1000s, 1/1500s, 1/2000s, 1/2500s, 1/4000s, 1/5000s, 1/10000s, 1/15000s, 1/20,000s, 1/25,000s, 1/30,000s, 1/40,000s, 1/50,000s	
(19) Trigger shutter mode	<ul style="list-style-type: none"> •Fixed Trigger Shutter Mode •Pulse Width Trigger Shutter Mode (Exposure time is set with the pulse width of trigger signal.) 	

Item	Specification	
(20) Safety/Quality standards	UL:	Conform to UL Standard including materials and others.
	CE:	Conform to EN55022: 2006 (Class B) for Emmission Conform to EN61000-6-2: 2005 for Immunity
	RoHS:	Conform to RoHS
	FCC:	To be applied for FCC Class A Digital Device This device complies with Part 15 of FCC Rules. Operation is subject to the following two conditions: (1) this device may not cause harmful interference, and (2) this device must accept any interference received, including interference that may cause undesired operation.
(21) Durability	Vibration	Acceleration : 98m/s ² (10G)
		Frequency : 20~200 Hz
		Direction : X,Y,Z 3 directions
		Testing time : 120 min for each direction
Shock	No malfunction shall be occurred with 980m/s ² (100G) for ±X, ±Y, and ±Z, 6 directions. (without package)	
(22) Operation environment	Temperature	Operation guaranteed: -5°C~+45°C Performance guaranteed: 0°C~+40°C
	Humidity	RH 20~80% with no condensation
(23) Storage environment	Temperature	-25°C ~ +60°C
	Humidity	RH 20~80% with no condensation

5.2. Camera Output Signal Specification

Item		Specification	
(1) Video output data	Video Output	2048 (H) × 1088(V)	At Full Frame Scan Mode
(2) Sync. Signal I/O	LVAL output	LVDS	Camera Link connector
	FVAL output	LVDS	
	DVAL output	LVDS	
	SP(Exposure)	LVDS	
(3) Trigger input	Polarity	POSI/NEGA Selectable	
	Min width of trigger pulse	10 μs	
	Camera Link input	LVDS : CC1 input	Camera Link connector
(4) Serial Communication	SerTC (Serial to Camera)	Camera Link input (LVDS)	
	SerTFG (Serial to Frame Grabber)	Camera Link output (LVDS)	
(5) Video output signal	White Clip Level	Digital 8bit	:FFh
	Setup Level	Digital 8bit	:00h
	Dark Shading	Digital 8bit	:Under ±04h for both vertical and horizontal. (Conditions: Gain 0dB)

5 seconds shall be waited after turning on power to get proper camera operation.

5.3. CMOS Spectral Response (Representative value)

※Lens characteristics and illuminant characteristics are not considered.

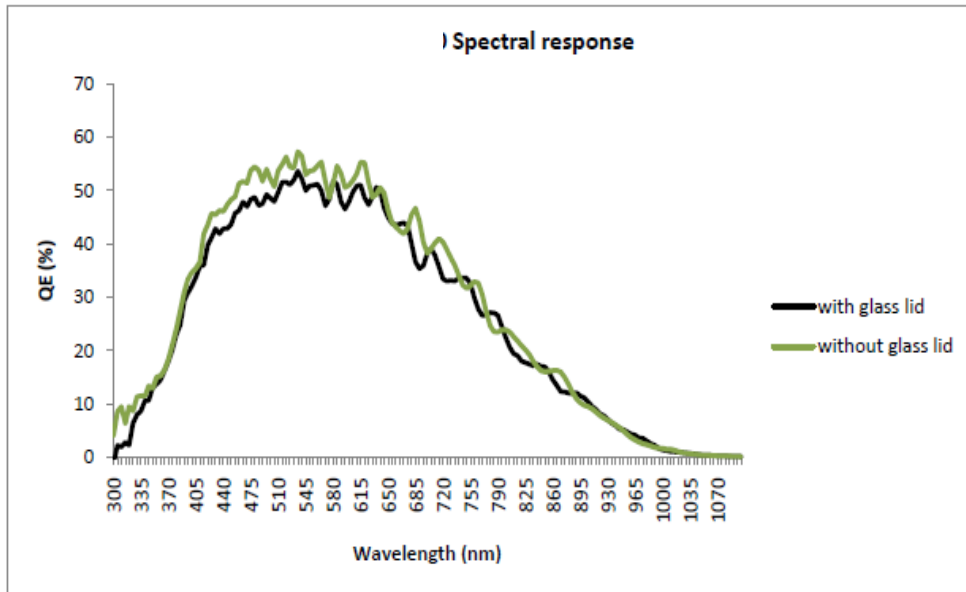

5.4. Video Output Format

UXGA 70fps Mode: 2Tap Interleaved

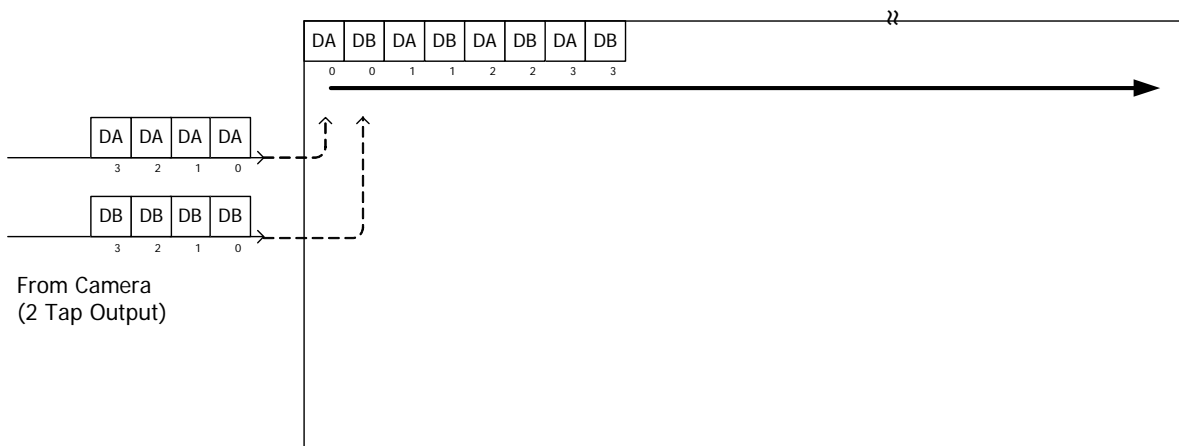

5.5. Camera Link Port Data Bit Assignment (Base Configuration)

Port/bit	At 8bit output setting	At 10bit output setting
Port A0	DA:bit0[LSB]	DA:bit0[LSB]
Port A1	DA:bit1	DA:bit1
Port A2	DA:bit2	DA:bit2
Port A3	DA:bit3	DA:bit3
Port A4	DA:bit4	DA:bit4
Port A5	DA:bit5	DA:bit5
Port A6	DA:bit6	DA:bit6
Port A7	DA:bit7[MSB]	DA:bit7
Port B0	DB: bit0[LSB]	DA:bit8
Port B1	DB: bit1	DA:bit9[MSB]
Port B2	DB:bit2	Not in use
Port B3	DB:bit3	Not in use
Port B4	DB:bit4	DB:bit8
Port B5	DB:bit5	DB:bit9[MSB]
Port B6	DB:bit6	Not in use
Port B7	DB:bit7[MSB]	Not in use
Port C0	Not in use	DB:bit0[LSB]
Port C1	Not in use	DB:bit1
Port C2	Not in use	DB:bit2
Port C3	Not in use	DB:bit3
Port C4	Not in use	DB:bit4
Port C5	Not in use	DB:bit5
Port C6	Not in use	DB:bit6
Port C7	Not in use	DB:bit7

6. Function Settings

Camera functions can be set with serial data communications.

Function	Address	Data
Gain	001	0: 0 dB
		1: +6 dB
		2: +12 dB
		3: Manual Gain (Refer to address 008.)
		4~255: 0dB
Shutter (at full frame scan mode) ※For partial scan mode, please refer to Section 9.	002	0: 1/70s
		1: 1/500s
		2: 1/750s
		3: 1/1000s
		4: 1/1500s
		5: 1/2000s
		6: 1/2500s
		7: 1/4000s
		8: 1/5000s
		9: 1/10000s
		10: 1/15000s
		11: 1/20000s
		12: 1/25000s
		13: 1/30000s
		14: 1/40000s
		15: 1/50000s
		16: Manual Shutter (Refer to address 009&010.)
17~255: 1/70s		
Trigger Shutter Mode	004	0: Normal Shutter Mode (Trigger Shutter Mode OFF)
		1: Fixed Trigger Shutter Mode (Shutter speed can be set with address 002.)
		2: Pulse Width Trigger Shutter Mode (Shutter speed can be set with trigger pulse width.)
		3~255: Normal Shutter Mode (Trigger Shutter Mode OFF)
Scan Mode	005	0: Full Frame Scan Mode
		1: Partial Scan Mode (Horizontal 1/2, Vertical 1/2)
		2: Manual Partial Scan Mode (Refer to address 016/017, 019/020, 023/024 & 027).
		3~255: Full Frame Scan Mode
Manual Gain Control	008	0~120: 0~+12dB 0.1dB/step ※Set the data of address 001 to 003.
		121~255: +12dB

Manual Shutter Control	009&010	<p>0~1088: 1/50000s~1/70s 1089~2047: 1088 ※ The setting will be 1 line when 0 is set. Exposure Time = The set value × 1line Time [s] 1line Time [s] = ((output pixels/2tap)+5) × 1/79.99MHz At full frame scan, output pixels = 2050 1line Time ≒ 12.88 μs At manual partial scan mode, output pixels = 640 + horizontal partial scan output pixel number x 10 Ex). When horizontal partial scan output pixel number is set to 0 (min), Output pixels = 640 and 1 line time ≒ 4.06 μs ※Address 002 data shall be 016. Address 009 MSB and Address 010 LSB make 11bit in total.</p>
Trigger Polarity	011	<p>0: Positive Input 1: Negative Input 2~255: Positive Input</p>
No Function	012	0: Fixed. Do not change.
Output Data Selection	013	<p>0: 8bit output data 1: 10bit output data 2~255: 8bit output data</p>
Vertical Partial Scan Start Position	016&017	<p>0~Max. Value ※ 1line/step ※Max. value shall be limited according to the formula below. 1088 (Vertical Partial Scan output max. lines – Vertical Partial Scan output lines) ※Address 005 data shall be 002. Address 016 MSB and Address 017 LSB make 11bit in total.</p>
Vertical Partial Scan Output Lines	019&020	<p>0~1088: 1line/step Min.:1line/Max :480 lines 1089~2047: 1088 ※ 1 line shall be set when 0 is set. Address 019 MSB and Address 020 LSB make 11bit in total. ※Address 005 data shall be 002.</p>
Horizontal Partial Scan Start Position	023&024	<p>0~Max. Value ※ 1line/step ※Max. value shall be limited according to the formula below. Max value = 2048 (Sensor - effective pixels) – output pixels (output pixels = 640 + horizontal partial scan output pixels value x 10) However, when 141 is set as horizontal partial scan output pixels, it will be 0. ※Address 005 data shall be 002. Address 023 MSB and Address 024 LSB make 11bit in total.</p>
Horizontal Partial Scan Output Pixels	027	<p>0~141: 10pixels/step Min.: 640 pixels/ Max : 2050 pixels 142~255: 141 (output pixels = 640 + horizontal partial scan output pixels value x 10)</p>
Remote Communication Baud Rate Setting	030	<p>0: 9600bps 1: 19200bps 2: 38400bps 3: 57600bps 4: 115200bps 5~255: 9600bps</p>
Data Save	032	Input 083 to save address 000 ~ 031 to EEP-ROM.

7. External Connector Pin Assignment

7.1. 26pins Mini Camera Link Connector 12226-1100-00 PL (SUMITOMO 3M)

Pin No.		Pin No.	
1	DC +12V	14	GND
2	X0-	15	X0+
3	X1-	16	X1+
4	X2-	17	X2+
5	Xclk-	18	Xclk+
6	X3-	19	X3+
7	SerTC+	20	SerTC-
8	SerTFG-	21	SerTFG+
9	CC1- (Trigger IN-)	22	CC1+ (Trigger IN+)
10	CC2+	23	CC2-
11	CC3-	24	CC3+
12	CC4+	25	CC4-
13	GND	26	DC +12V

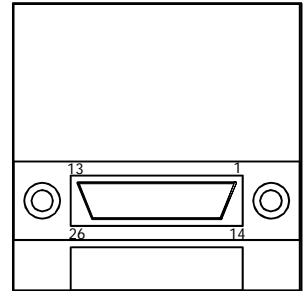

8. Timing Chart

8.1. Horizontal Synchronous Signal Timing

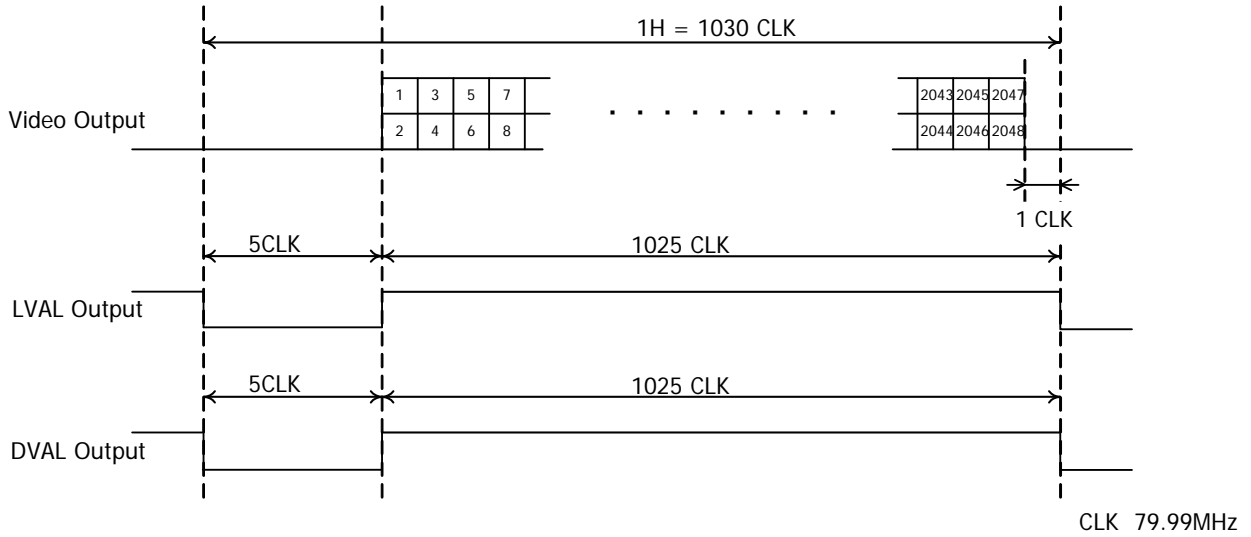

8.2. Vertical Synchronous Signal Timing

8.2.1 Full Frame Scan Mode

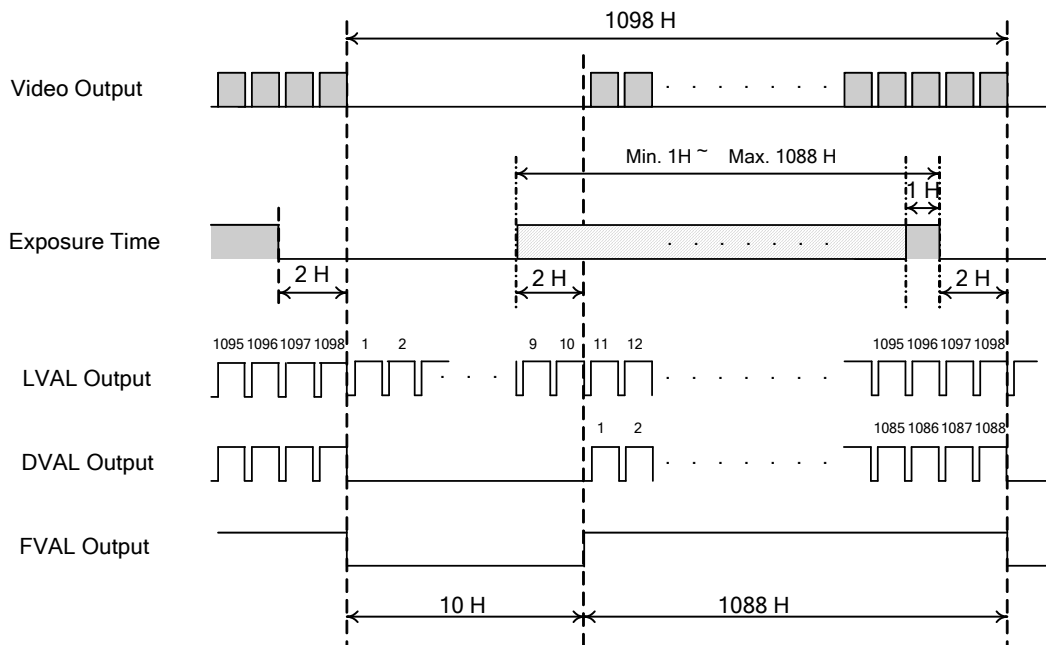

※Video output signal delays by 2H from Exposure Time.

8.2.2 Fixed Trigger Shutter Mode

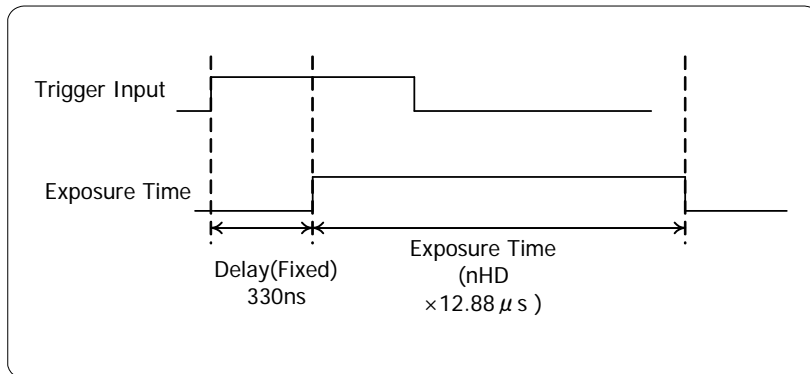
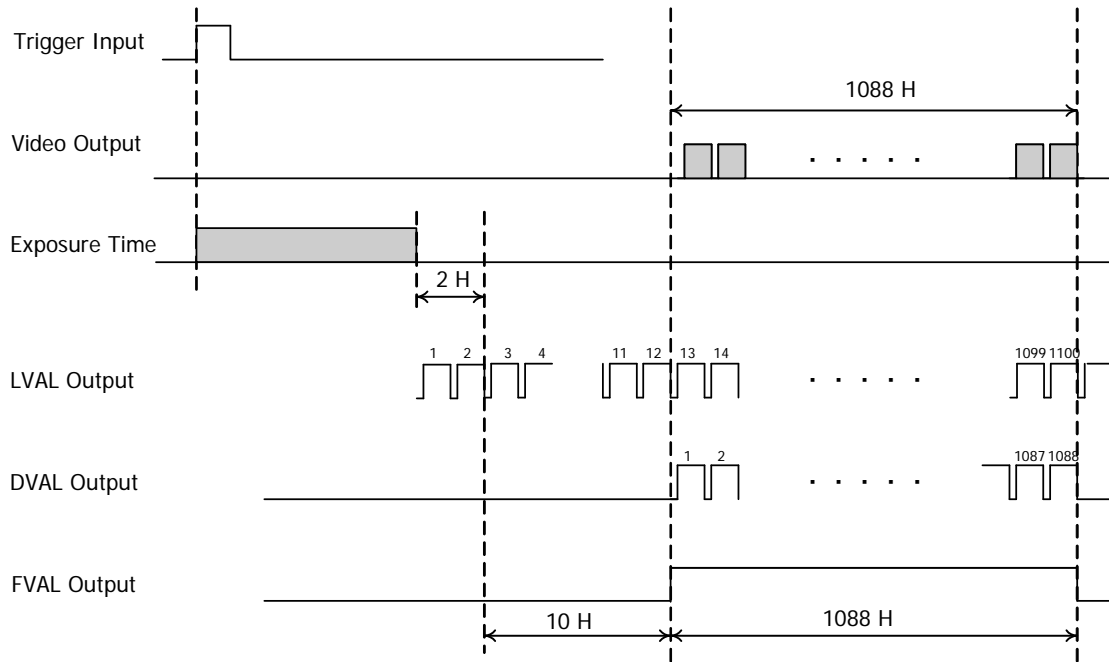

※Video output signal delays by 2H from Exposure Time.

8.2.3 Pulse Width Trigger Shutter Mode

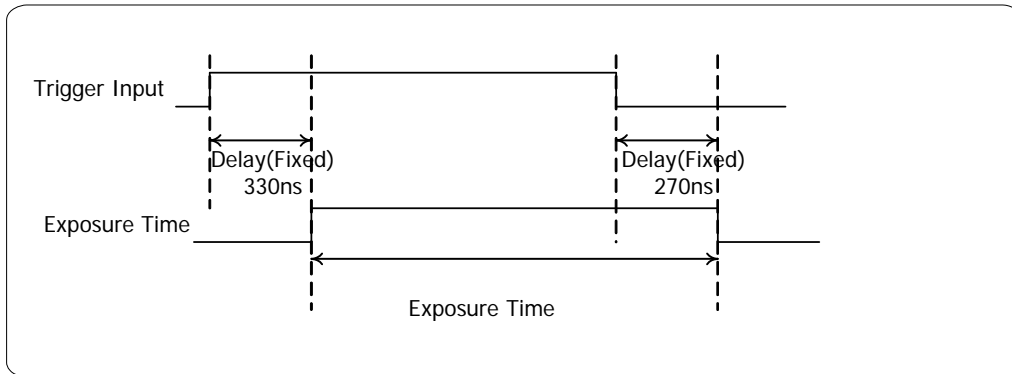
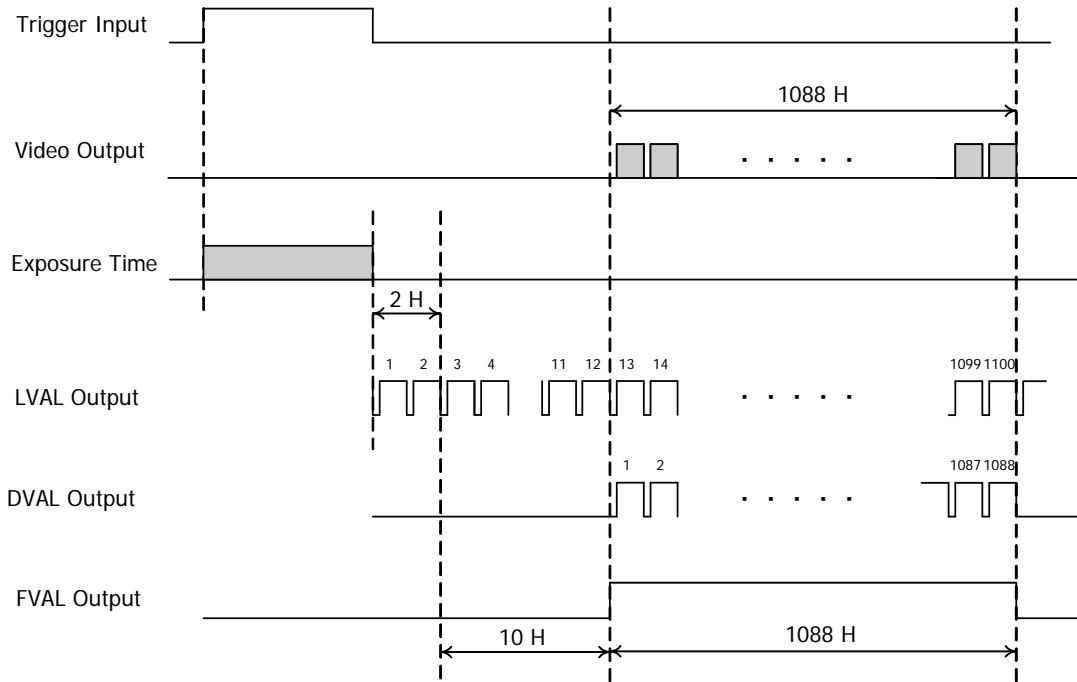

※Video output signal delays by 2H from Exposure Time.

9. Partial Scan Mode
 9.1. Horizontal Partial Scan

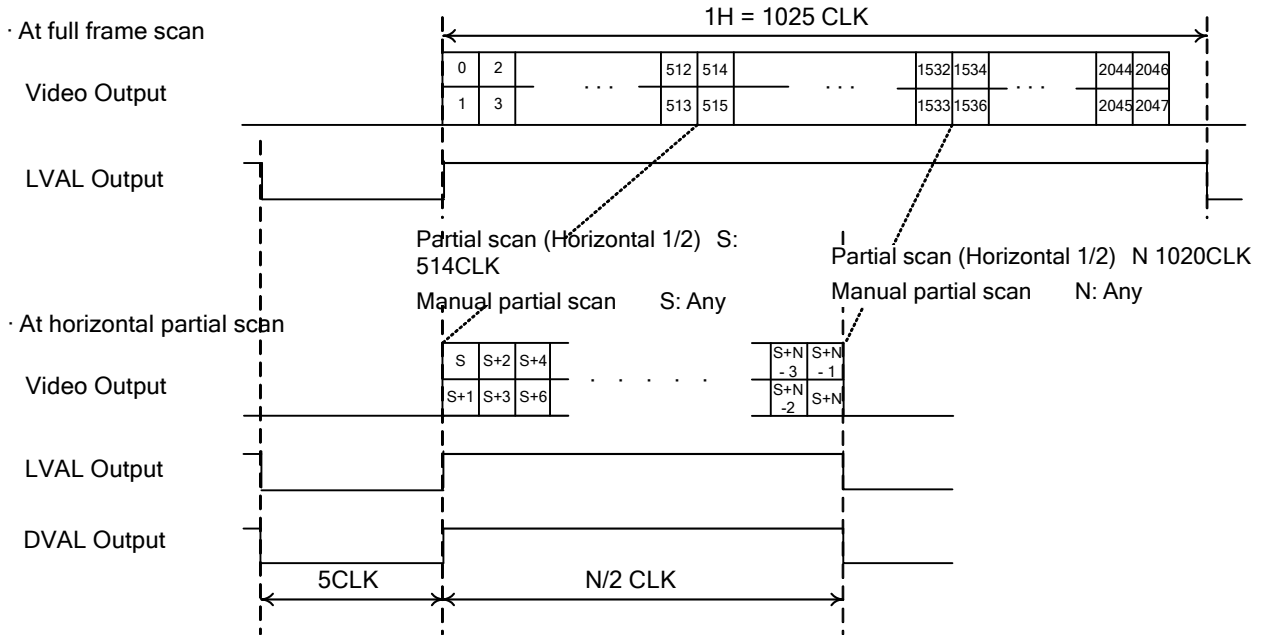

S: Horizontal partial scan starting position (address 023 & 024)

N: Output pixels (Output pixels = 640 + Horizontal partial scan output pixels set value (address 027) x 10)

Scan Mode (address:005)	S	N	Horizontal Sync. Frequency (kHz)
0: Full frame scan mode	0	2050	77.66
1: Partial scan mode (Horizontal 1/2, Vertical 1/2)	514	1020	155.32
2: Manual partial scan mode	Any	Any	79.99MHz / ((output pixels/2 tap) + 5)

- The max value of horizontal partial scan starting position is limited with the formula below since output pixel number has priority.
 The max value of horizontal partial scan starting position = 2048 (sensor effective pixels) – output pixel number
 Output pixel number = 640 + (horizontal partial scan output pixel set value x 10)

(Ex.) When 10 is set as horizontal partial scan output pixel number, the max value of horizontal partial scan starting position will be 2048 – (640 + 10 x 10) = 1308.

If horizontal partial scan starting position is set to 1318 with this time, output pixel number has priority so that horizontal partial scan starting position shall be limited to 1308.

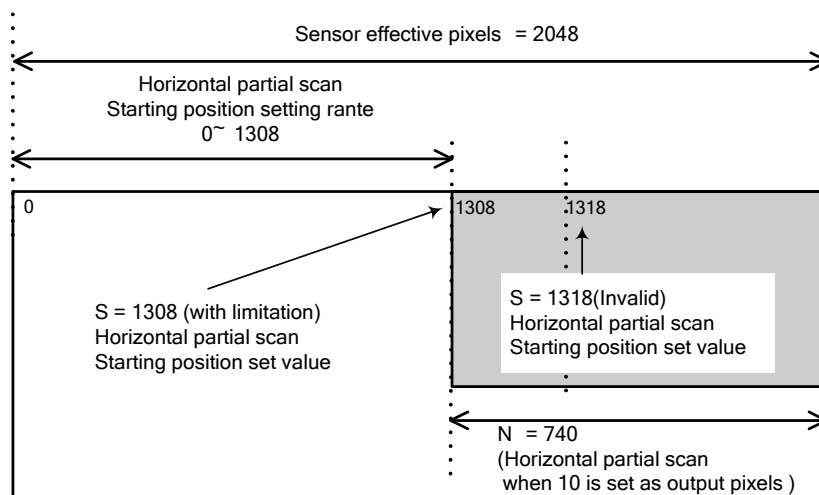

9.2. Vertical Partial Scan

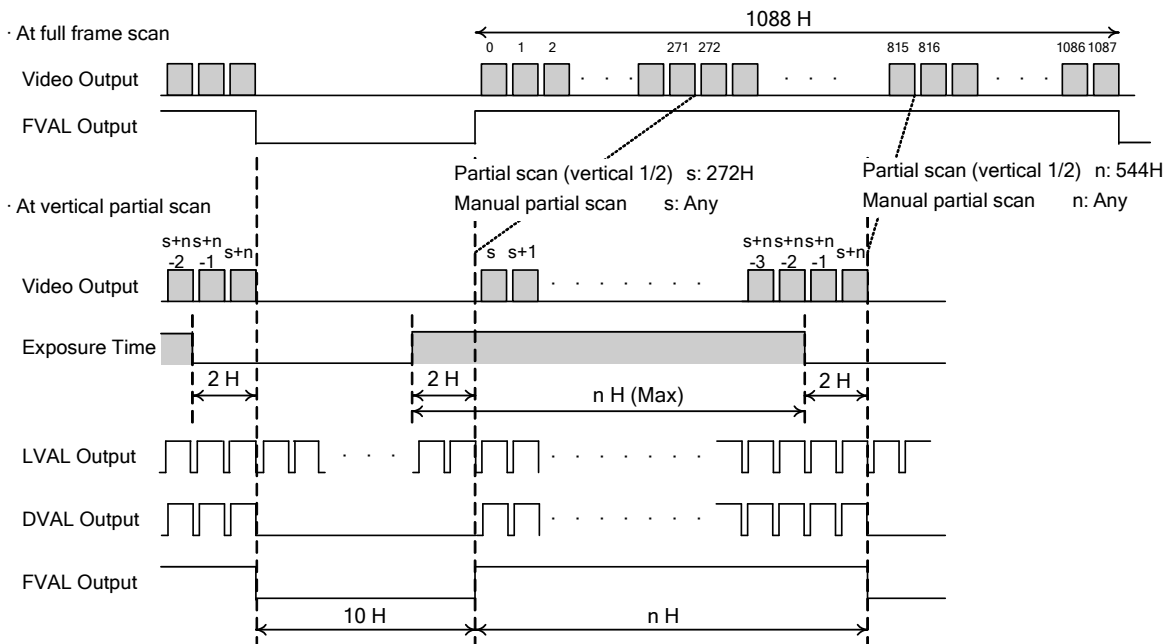

s: Vertical partial scan starting position (address 016&017)

n: Vertical partial scan output lines (address 019&020)

Scan Mode (address:005)	s	n	Vertical Sync. Frequency (Hz)
0:Full frame scan mode	0	1088	70.73
1:Partial scan mode (Horizontal 1/2, Vertical 1/2)	272	544	280.36
2:Manual partial scan mode	Any	Any	$79.99\text{MHz} / ((\text{vertical partial scan output line number} + 10) \times (\text{output pixel number} / 2\text{Tap} + 5))$

•The max value of vertical partial scan starting position is limited with the formula below since vertical partial scan output line has priority.

The max value of vertical partial scan starting position

$$= 1088 - (\text{The max value of vertical partial scan output line}) - \text{Vertical partial scan output lines}$$

(Ex.) When 480 is set as vertical partial scan output lines, the max value of vertical partial scan starting position will be $1088 - 480 = 608$.

If vertical partial scan starting position is set to 618 with this time, vertical partial scan output line has priority so that vertical partial scan starting position shall be limited to 608.

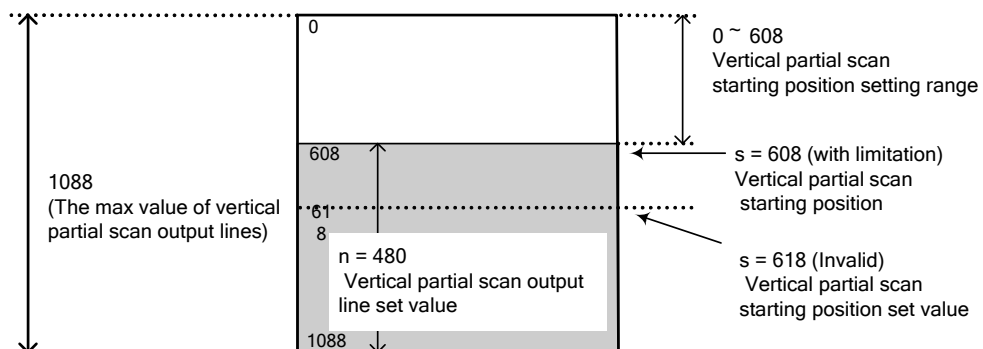

※ At manual partial scan mode, manual shutter value to be set shall meet the following conditions.

The set manual shutter lines \leq Vertical partial scan output lines

If the condition above is not met, shutter lines to be set will be the same number as vertical partial scan output lines.

10. Remote Interface Function

Camera can be controlled by external computers and others via camera link interface.

(1) The settings for RS-232C are as follows.

Baud Rate : 9600bps, 19200bps, 38400bps, 57600bps, 115200bps
 Data : 8bit
 Stop bit : 1bit
 Parity : None
 XON/XOFF : not controlled

(2) Control code

- The total control code is 14 bits, which conforms to ASCII code.
- The control code consists of camera No. process code, remote controller address, remote controller data, and CR. Execute Read/Write through PC, and the camera will reply the data.

1	2	3	4	5	6	7byte	8	9	10	11	12	13	14
Camera No.						Process code	Remote controller address			Remote controller data			CR
000000: Common No.						"R" Read mode	Please refer to the address table of 6. Function setting.			000~255			0Dh
Dedicated Camera No.						"W" Write mode							
						"C" Camera mode							

Camera No

Please send the common code, "000000", consist of 6 bytes of characters/numeric strings.

The returned data from the camera shall be the dedicated camera No assigned for that specific camera.

Process code

Input any one of R, W, or C to the process code.

R (read mode) is to read the data of remote controller address.

Please be noted to set any dummy data (000~255) to 11th ~13th, since a command shall consists of 14 bytes.

W (write mode) is to write the data to the remote controller address.

Please be noted that the data cannot be saved into EEPROM of the camera.

(Reboot the camera, and the data is reset to the initial setting.)

To save the data into EEPROM, please refer to Clause 5. Function Setting.

Note: Once the data was saved into EEPROM, it may not be reset to the initial settings.

C is the code to send the data back from the camera.

Note: Do not set code C when sending the data from PC side.

Remote controller address

Note: Do not save the data into the address other than specified, since it may cause the damages or malfunction of the camera.

Remote controller data

Set the decimal number (000~255) for the remote controller data. Please be noted to set any dummy data at read mode.

CR

Be sure to input "CR" to confirm the end of the command.

11. Initial Settings

Function	Address	Data
Gain	001	0: 0dB
Shutter	002	0: 1/70s
Trigger Mode	004	0: Normal Shutter Mode (Trigger Shutter Mode OFF)
Scan Mode	005	0: Full Frame Scan Mode
Manual Gain Control	008	0: 0dB
Manual Shutter Control	009&010	1088: 1/70s
Trigger Polarity	011	0: Positive Input
Output Data Selection	013	0: 8bit Output Data
Baud Rate	030	0:9600bps

12. CMOS Optical Axis Accuracy

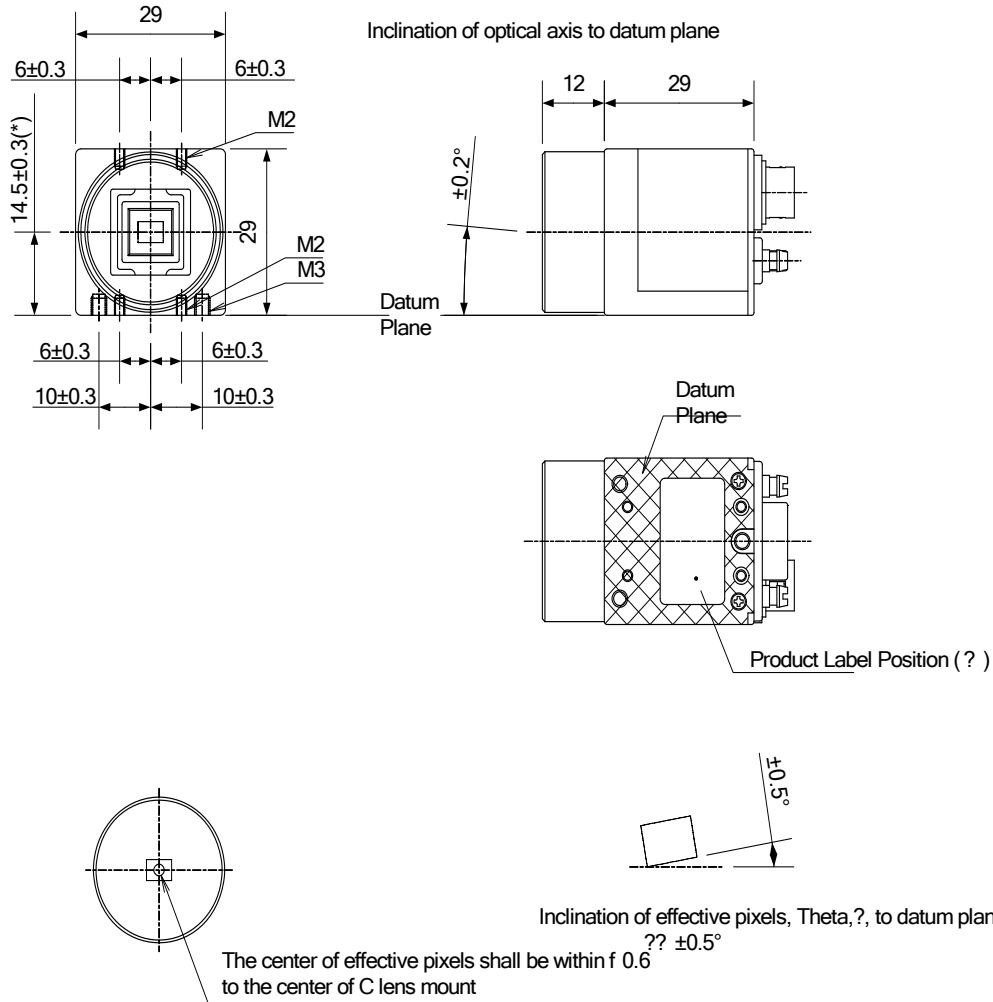

(*) Dimensions from datum plane to the center of the lens mount

910-006-01-01
(Unit:mm)

13. Dimensions

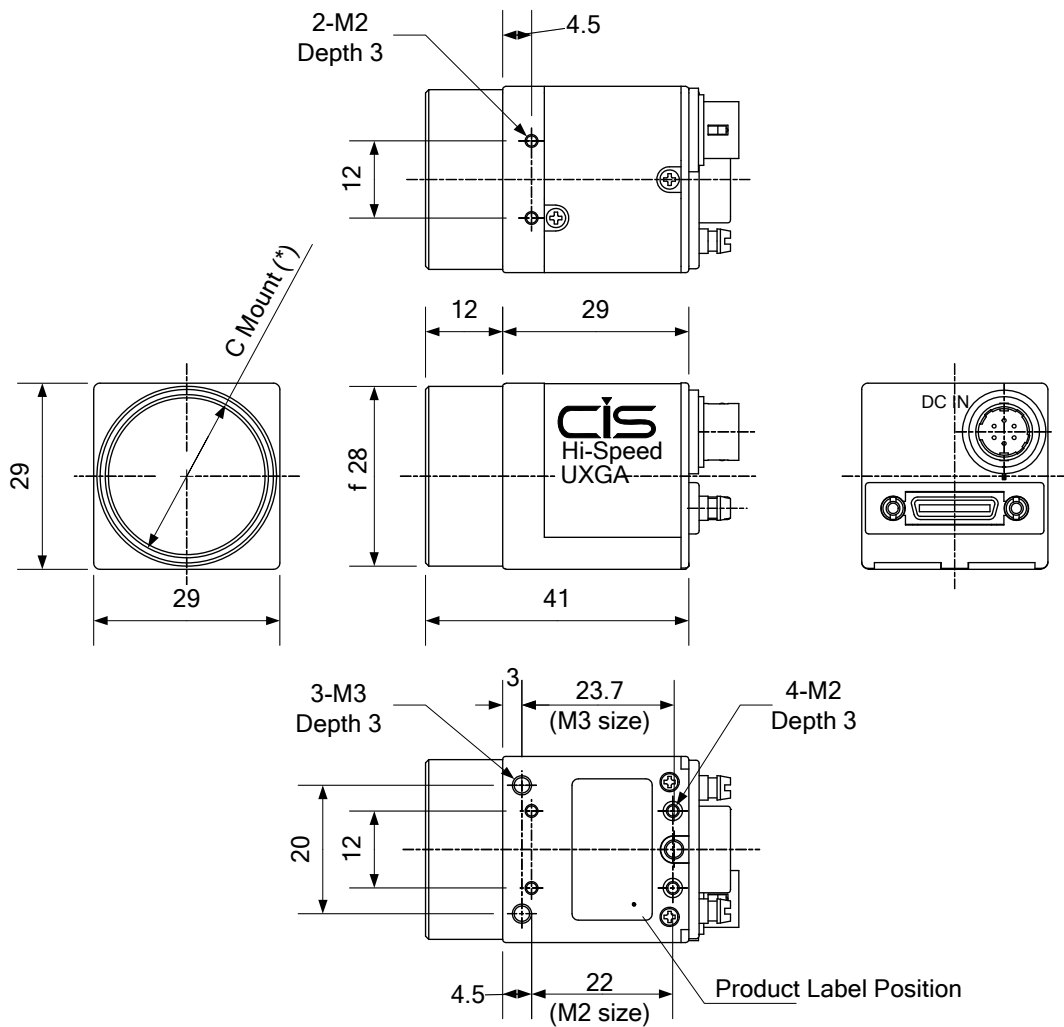

*2)C mount screws comply with ANSI/ASME B1.1, 1-32UN(2B).

*1)Screw length from the lens mount surface shall be under 6mm.

And protruding portion shall be less than 10mm.

999-547-00-00

(Unit:mm)

14. Cases for Indemnity (Limited Warranty)

We shall be exempted from taking responsibility and held harmless for damage or losses incurred by the user in the following cases.

- ✧ In case damage or losses are caused by fire, earthquake, or other acts of God, acts by third party, deliberate or accidental misuse by the user, or use under extreme operating conditions.
- ✧ In case indirect, additional, consequential damages (loss of business interests, suspension of business activities) are incurred as result of malfunction or non-function of the equipment, we shall be exempted from responsibility for such damages.
- ✧ In case damage or losses are caused by failure to observe the information contained in the instructions in this product specification & operation manual.
- ✧ In case damage or losses are caused by use contrary to the instructions in this product specification & operation manual.
- ✧ In case damage or losses are caused by malfunction or other problems resulting from use of equipment or software that is not specified.
- ✧ In case damage or losses are caused by repair or modification conducted by the customer or any unauthorized third party (such as an unauthorized service representative).
- ✧ Expenses we bear on this product shall be limited to the individual price of the product.

15. Sensor Pixel Defect

Sensor pixel defects might be noted with time of usage of the products.

Cause of the Sensor pixel defects is the characteristic phenomenon of CMOS itself and CIS is exempted from taking any responsibilities for them.

16. Product Support

When defects or malfunction of our products occur, and if you would like us to investigate on the cause and repair, please contact your distributors you purchased from to consult and coordinate.

Camera control sample software (RS232C) is downloadable from our web but we shall be exempted from taking responsibility and held harmless for damage or malfunction of your hardware and software caused by using this control software. The purpose of the control software prepared is for you to check operation and evaluate our products. Please be noted that CIS does not customize the program nor provide source code.