



English

**SXGA B/W Camera  
72MHz Pixel Clock Camera Link**

**VCC-G32S21CL**

**Product Specification  
& Operation Manual**

**CIS Corporation**

## Table of Contents

1. Scope of Application .....	3
2. Notice .....	3
3. Product Outline .....	3
4. System Connection Diagram.....	4
5. Specification .....	5
5.1. General Specification.....	5
5.2. Camera Output Signal Specification .....	6
5.3. Camera Link Connector Bit Assignment (Base Configuration).....	8
5.4. Function Setting.....	9
6. External Connector Pin Assignment.....	12
6.1. 12 pins Circular Connector HR10A-10R-12PB.....	12
6.2. 26 Pins Compact Camera Link Compatible Connector (3M) .....	12
7. Switch Settings, Adjustment Potentiometer Specifications.....	13
7.1. Rear Panel Switch Function 10bit DIP-SW.....	13
7.1.1. Shutter Speed Settings (Rear panel SW1: E0, SW2: E1, SW2: E2) .....	13
7.1.2. Operation Mode Settings (Rear panel SW4: MODE0, SW5: MODE1) .....	14
7.1.3. Partial Scan Setting Switch (Rear Panel SW: 6 SCAN) .....	15
7.1.4. (Rear Panel SW7: -).....	17
7.1.5. (Rear Panel SW8: -).....	17
7.1.6. 8 bit / 10bit Selection Switch (Rear Panel SW9: 8Bit/10Bit) .....	17
7.1.7. HD / VD Input / Output Selection Switch (Rear panel SW10: IN/OUT) .....	17
7.1.8. WEN (Write Enable) Signal Output.....	17
7.2. 12 Turn Rotary Potentiometer for Manual Gain Adjustment .....	17
7.3. Internal Adjustment Switches and Potentiometer Information .....	18
7.4. HD/VD Trigger Input/Output Circuit of 12pin Circular Connector.....	19
7.5. Remote Interface Function .....	20
8. Safety/Quality Standards.....	21
9. Durability.....	22
10. Timing Chart.....	23
10.1. Horizontal Synchronous Signal Timing.....	23
10.2. Vertical Synchronous Timing.....	24
10.3. Vertical Synchronous Timing (73 fps Partial Scan Mode) .....	25
10.4. Standard Trigger Timing.....	26
10.5. Pulse Width Trigger Timing .....	27
11. Dimensions .....	28
12. Cases for Indemnity (Limited Warranty) .....	29
13. Handling Precautions .....	30

## 1. Scope of Application

This is to describe VCC-G32S21CL Camera Link B/W CCD Camera. All specifications contained herein are subject to change without prior notice. Reproduction in whole or in part is prohibited.

## 2. Notice

The camera must not be used for any nuclear equipments or aerospace equipments with which mechanical failure or malfunction could result in serious bodily injury or loss of human life. Our warranty does not apply to damages or defects caused by irregular and/or abnormal use of the product. Please refer to Clause 13. Handling Precautions.

## 3. Product Outline

VCC-G32S21CL is a high-resolution industrial B/W digital video camera module utilizing a 1/2 inch PS IT CCD. 1450K pixels CCD image sensor with on-chip micro-lenses realizes high sensitivity and high resolution.

### Key Features.

#### Electronic shutter

Fixed Electronic shutter speed switchable by rear switch

OFF (1/38s) ~ 1/10,000s : 8 steps

OFF (1/38s) ~ 1/2.375s : 5 steps (slow shutter)

Electronic shutter speed switchable by trigger pulse width

Approx. 1/2s ~ 1/10,000s

#### Video frame rates

The following is for both normal mode and trigger mode.

Progressive Scan: 38 fps

Partial Scan: 73 fps ~ 48 fps (Initial Setting is 73 fps)

#### Input Trigger

The input trigger inputted during the execution of prior trigger shall be ignored.

Ex. When the shutter speed is set to 1/1,000sec, signal read out period will be over 27.55ms.

(Exposure time 1ms + video out 26.55ms.)

#### Camera Link

By use of dedicated cable, VCC-G32S21CL can be connected to Camera Link capture board.

4. System Connection Diagram

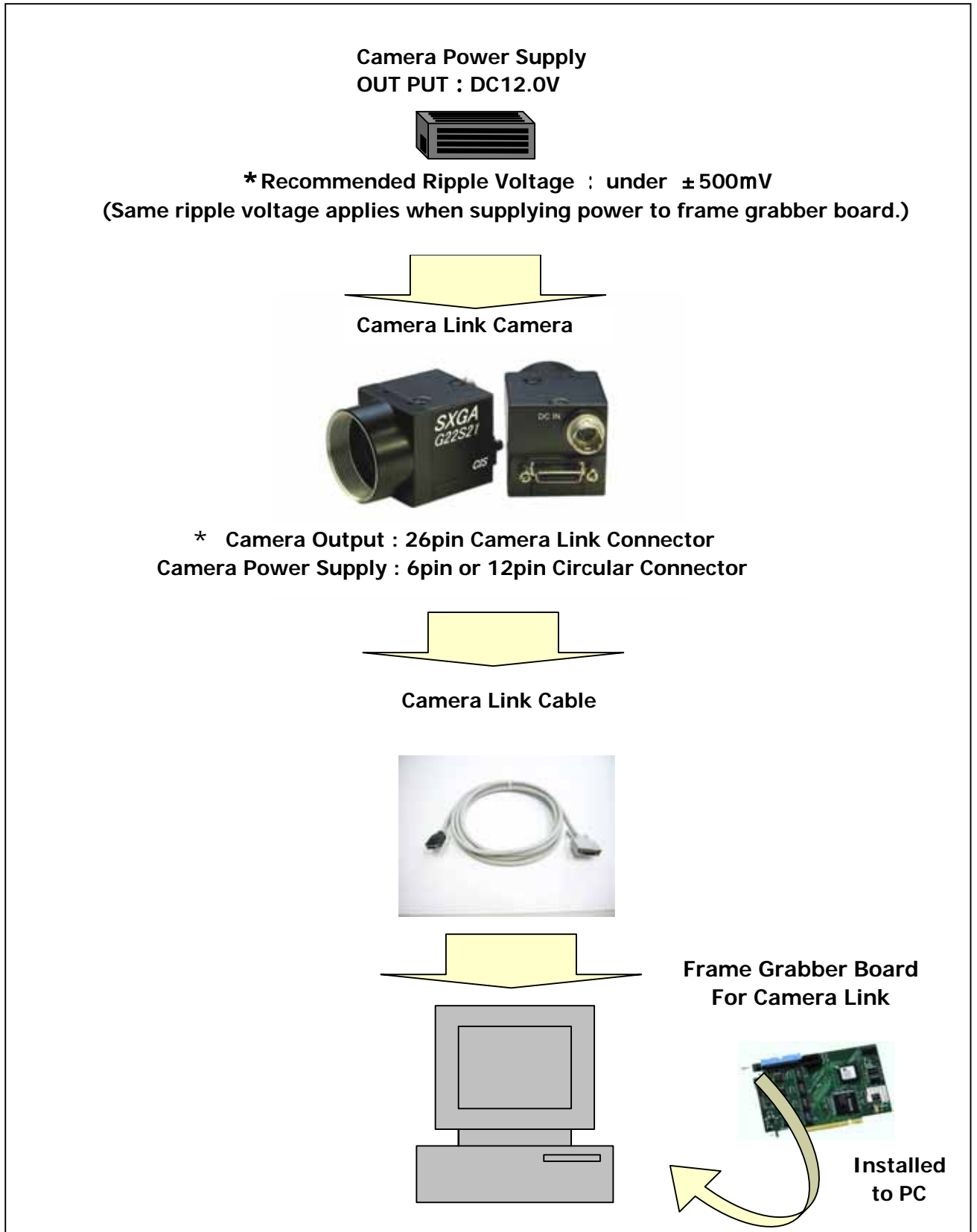

## 5. Specification

### 5.1. General Specification

Item	Specification	Remarks
Power consumption	3.7W	
Power requirements	DC +12V $\pm$ 10% (Max voltage not to exceed 15V)	
Operation environment	(Performance Guaranteed) 0 ~ +40 with RH 20 ~ 80% (Operation Guaranteed) -5 ~ +45 with RH 20 ~ 80% Note: No condensation	
Storage environment	-25 ~ +60 with RH 20 ~ 80% Note: No condensation	
Mass	Approx. 140 g	
Dimension	Refer to overall dimension drawing (Clause 11) 44mm x 29mm x 71.5mm (excluding projection)	
Lens mount	C mount (Flange back: 17.526mm) fixed.	
Back Focus	10.99 mm	
Optical axis accuracy	Center $\pm$ 0.1mm and under	
Video output signal	Digital RAW data 8 bit/10bit Camera Link output	Camera Link output
Pick up device	1/2" Interline Transfer B/W CCD Total Pixel number 1392 (H) x 1040 (V) Recommended Pixel number 1360 (H) x 1024 (V) Unit cell size 4.65 $\mu$ m (H) x 4.65 $\mu$ m (V)	ICX267AL (Sony) Progressive Scan
Operation Mode	(1) Normal Operation Mode (Internal Sync) (2) HD/VD External Sync Operation Mode Allowable Frequency Deviation $\pm$ 1% Jitter shall be less than 20ns. (3) External Trigger Operation Mode Input via camera Link connector or 12 pin circular connector. <ul style="list-style-type: none"> <li>• Normal Trigger Operation Mode</li> <li>• Trigger Pulse Width Operation Mode</li> <li>• Normal Trigger Operation Mode (Slow Shutter)</li> </ul>	12pin Circular Connector

Item	Specification	Remarks
Scanning system Non-Interlaced	1/38sec Progressive Scan (Normal Operation)	1790 CLK 1068 HD
	Horizontal frequency      40.22 KHz	
	Vertical frequency          37.66 Hz	
	Pixel clock                    72 MHz	
Partial Scan	V Scanning      Rate      Effective V line	Refer to 7.1.3 for the details
	OFF Progressive 1068 lines      38 fps      1024 lines	
	Partial Scan      550 lines      73 fps      258 lines (min 548 line:73 fps: 255 line ~ max 832 line:48 fps: 681 line)	
Sensitivity	F2.8      400 lx      (at 1/38 sec exposure, Gain 0dB)	
Min. illumination	F1.4      0.5 lx (at 1/38 sec exposure, Gain 12dB, VS 50 IRE)	

## 5.2. Camera Output Signal Specification

Item	Specification	Remarks	
Horizontal resolution	1024 TV lines		
Sync. Signal I/O	(1) LVAL output (2) FVAL output (3) DVAL output	Polarity Negative Polarity Negative BLK output (effective pixel area), Positive	Camera Link connector
	(1) HD/VD Input (2) HD/VD Output (3) WEN Output	Polarity Negative (at External Sync mode) Input level shall be 2 ~ 5Vp-p with connected to the camera. HD/VD signals shall not include noises such as chattering. Polarity Negative (at Internal Sync mode) Single VD/FVAL/Exposure selectable (at External sync mode)	12pin Circular connector  (Refer to Address 55)
	Please refer to 7.4. 12 pin Circular Connector HD/VD trigger I/O circuit.		
	Polarity	POSI/NEGA Selectable	Refer to Address 011
Trigger input	Input signal level	Input level shall be 2 ~ 5Vp-p with connected to the camera. Trigger input shall not include noises such as chattering.	12 pin circular connector
		CC1 Input	Camera Link connector
	Min. Trigger Pulse width	Over 1 HD	

Item	Specification	Remarks
Video Output Signal	Setup level : 23 ± 5 (Hex) to 8 bit video output (00 – FF Hex)	
Shutter	(1) Normal Operation Mode OFF(1/38), 1/76, 1/114, 1/152, 1/500, 1/1000, 1/5000, 1/10000 sec OFF(1/73), 1/76, 1/114, 1/152, 1/500, 1/1000, 1/5000, 1/10000 sec	(Normal operation) (Partial operation)
	(2) Standard Trigger Operation Mode 1/38, 1/76, 1/114, 1/152, 1/500, 1/1000, 1/5000, 1/10000 sec 1/73, 1/76, 1/114, 1/152, 1/500, 1/1000, 1/5000, 1/10000 sec	(Normal operation) (Partial operation)
	(3) Trigger Pulse Width Operation Mode Approx. 1/4 ~ 1/10000 sec (controlled by 1HD trigger pulse width)	
	(4) Standard Trigger Operation Mode (Slow shutter) 1/38, 1/19, 1/9.5, 1/4.75, 1/2.375 sec 1/73, 1/36.5, 1/18.25, 1/9.125, 1/4.563 sec	(Normal operation) (Partial operation)
	When jitter occurs between internal HD and trigger pulse width, exposure time will be changed 1HD. Please input 1HD to avoid fluctuation.	
	Gain	0dB. +6dB, Manual (min –1dB ~ max +12dB) Function guaranteed: 0 ~ +6dB. When gain is set over +6dB, artifacts such as vertical stripes, beat noises, and shadings may become visible.
	OFF ( = 1.0), ON ( = 0.45), Select (Option)	
Remote Control	Via camera link connector or 12 pins circular connector, the camera can be remote controlled. When the camera is remote controlled via 12 pins circular connector, HD/VD input and output of 12 pins connector can not be used.	

### 5.3. Camera Link Connector Bit Assignment (Base Configuration)

8 bit Data output (Rear switch 8:OFF, 9:OFF)

Port/bit	Data bit	Port/bit	Data bit	Port/bit	Data bit
Port A0	D0	Port B0	D0	Port C0	D0
Port A1	D1	Port B1	D1	Port C1	D1
Port A2	D2	Port B2	D2	Port C2	D2
Port A3	D3	Port B3	D3	Port C3	D3
Port A4	D4	Port B4	D4	Port C4	D4
Port A5	D5	Port B5	D5	Port C5	D5
Port A6	D6	Port B6	D6	Port C6	D6
Port A7	D7	Port B7	D7	Port C7	D7

3 tap output. (8 bit x 3). Port A = Port B = Port C

10 bit Data output (Rear switch 8:OFF, 9:ON)

Port/bit	Data bit	Port/bit	Data bit	Port/bit	Data bit
Port A0	D0	Port B0	D8	Port C0	D0
Port A1	D1	Port B1	D9	Port C1	D1
Port A2	D2	Port B2	Nc	Port C2	D2
Port A3	D3	Port B3	Nc	Port C3	D3
Port A4	D4	Port B4	D8	Port C4	D4
Port A5	D5	Port B5	D9	Port C5	D5
Port A6	D6	Port B6	Nc	Port C6	D6
Port A7	D7	Port B7	Nc	Port C7	D7

2 tap output. (10 bit x 2).

## 5.4. Function Setting

Camera functions can be set with serial data communications.

Function	Address	Data	Remarks
LOC/REM	000	0: Local (Camera SW) Control      1: Remote Control	F, G
Gain	001	0: - 1 dB 1: 0 dB 2: + 6 dB 3: +12 dB 4: Manual Gain (Refer to address 008.)	F, G
E-Shutter Position	002	0 ~ 7: Refer to 7.1.1. Shutter Settings 8 ~ 15: - 16: Manual Shutter (Refer to address 009 & 010.)	F, G
White Balance	003	0: 2600 ° K 1: 3200 ° K 2: 5600 ° K 3: 9000 ° K 4: Manual White Balance (Refer to address 006 & 007.)	F
Trigger Mode	004	0: Normal Mode 1: Standard Trigger Mode 2: Pulse Width Trigger Mode 3: Standard Trigger Mode (Slow Shutter)	F, G Initial Setting (0)
Scan Mode	005	0: Normal Scan Mode 1: Partial Scan Mode	F, G Initial Setting (0)
Manual R Gain	006	R Gain 64 ~ 255      Valid when address 003 data is 4 (Manual).	F
Manual B Gain	007	B Gain 64 ~ 255      Valid when address 003 data is 4 (Manual).	F
Manual Gain	008	0 ~ 255: -1dB ~ +12dB      Valid when address 001 data is 4 (Manual).	F, G
Manual Shutter Control	009 & 010	<ul style="list-style-type: none"> <li>• Normal Scan (Address 005:0) 0 ~ max 1067 (max address 009:4, address 010:043) Shutter speed = <math>1 / ((1067-DATA)*24.86 \mu s + 12.43 \mu s)</math></li> <li>• Partial Scan (Address 005:1) 0 ~ max (address 052 &amp; 053-1) Shutter speed = <math>1 / ((address\ 052\&amp;\ 053-1)-DATA) * 24.86 \mu s + 12.43 \mu s</math></li> <li>• Address 009 MSB and address 010 LSB make 10 bits in total.</li> </ul>	

F . . . F32 Color camera series only.

G . . . G32 B/W camera series only.

Function	Address	Data	Remarks
Trigger Polarity Neg/Pos	011	0: Trigger Positive Input 1: Trigger Negative Input	F, G Initial setting (0)
Input Trigger Port Select	012	0: Camera Link 1: 12pin Circular connector	F, G Initial setting (0)
8 bit / 10 bit	013	0: 8bit Output Data 1: 10bit Output Data Valid when address 018 data is 0 (RAW).	F (RAW), G Initial setting (0)
Gamma	014	0: =1.0 (OFF), 1: =0.45 (ON) (option)	F, G Initial setting (0)
No Function	015	Not used.	
Aperture	016	0: Aperture OFF, 1-3: Aperture ON	G Initial setting (0)
No Function	017	Not used.	
No Function	018	Not used.	
No Function	019	Not used.	
HD In/Out	020	0: HD, VD output 1: HD, VD input	F, G Initial setting (0)
8 bit Format	021	0: 9-2 bit (Upper) 1: 8-1 bit (Middle) 2: 7-0 bit (Low)	F (RAW), G Initial setting (0)
Cursor ON/OFF	022	0: OFF 1: ON	F (RAW), G Initial setting (0)
Cursor H address	023 & 024	Cursor H address (023: H Byte      024: L Byte)	F (RAW), G
Cursor V address	025 & 026	Cursor V address (025: H Byte      026: L Byte)	F (RAW), G
No Function	022 – 047	Not used.	
Partial Scan Effective lines	048 & 049	Partial Scan effective line number (048: V Byte, 049: L Byte) 255 linse + 3 * setting value (0 ~ max 142) : min 255 lines ~ max 681 lines Initial value: 0, 1 (258 lines)	F, G (3 line/step)
Partial Scan Start Position	050 & 051	Partial Scan Start Position (050: V Byte, 051: L Byte) : min 0 ~ 258 (address 048&049 data) Initial value: 0, 133	F, G (3 line/step)

F . . . F32 Color camera series only.

G . . . G32 B/W camera series only.

Function	Address	Data	Remarks
Partial Scan Total line number	052 & 053	Partial Scan Total Line number (052: V Byte, 053: L Byte) 548 line +2 * (address 048 & 049 value) : min 548 lines ~ max 832 lines Initial value: 2, 38 (550lines) Note: Read only	F, G Read Only
No Function	054	Not used	
WEN Format	055	0: VD (9H), 1: FVAL, 2: Exposure, 3: -	F, G Initial setting (0)
Output INV	056	0: Normal 1: Invert	F, G Initial setting (0)
Partial Scan Blanking	057	0: Normal 1:35 line Blanking Valid when address 005 is 1 (Partial Scan Mode)	F, G Initial setting (0)
No Function	058 – 062	Not used	
Data Save	063	Input "083" to save the data to EEPROM. Note; Camera internal SW 104-2 shall be ON to save the data.	F, G

F . . . F32 Color camera series only.

G . . . G32 B/W camera series only.

## 6. External Connector Pin Assignment

### 6.1. 12 pins Circular Connector HR10A-10R-12PB

Pin No.	
1	GND
2	POWER IN DC +12V
3	GND
4	NC
5	GND
6	HD IN/OUT (RS232C RXD)
7	VD IN/OUT (RS232C TXD)
8	GND
9	NC
10	WEN OUT
11	TRG IN
12	GND

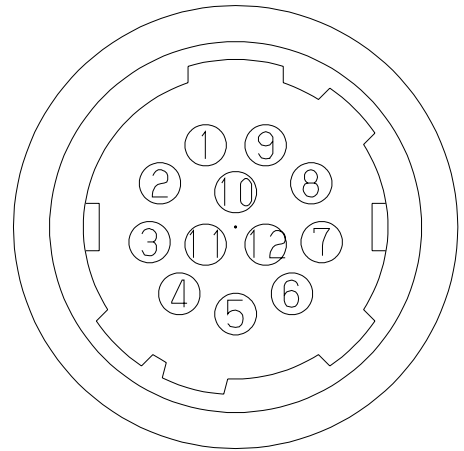

It is possible to change the HD, VD I/O pins into port RS232C RXD TXD for the remote communication. ( optional feature )

### 6.2. 26 Pins Compact Camera Link Compatible Connector (3M)

Signal	Specification	
LVAL	HD	
FVAL	VD	
DVAL	Composite Blanking ( Effective image area )	
SP	-	
Signal	Camera Link Pin No.	Specification
XCLK-	5	CLK OUT
XCLK+	18	
SerTC+	7	RS232C RXD (Serial to camera)
SerTC-	20	
SerTFG+	8	RS232C TXD (Serial to frame grabber)
SerTFG-	21	
CC1-	9	TRG IN
CC1+	22	
CC2+	10	No Function
CC2-	23	
CC3-	11	No Function
CC3+	24	
CC4+	12	No Function
CC4-	25	

## 7. Switch Settings, Adjustment Potentiometer Specifications

### 7.1. Rear Panel Switch Function 10bit DIP-SW

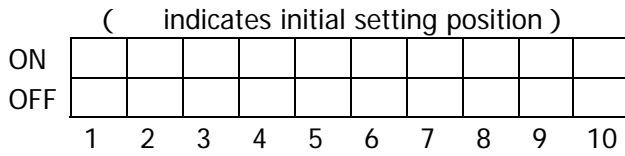

- |    |            |   |                                                                                                              |
|----|------------|---|--------------------------------------------------------------------------------------------------------------|
| 1  | E0         | } | Electronic shutter speed (3bit)                                                                              |
| 2  | E1         |   |                                                                                                              |
| 3  | E2         |   |                                                                                                              |
| 4  | MODE0      |   | trigger mode (2bit)                                                                                          |
| 5  | MODE1      |   | 0:standard mode 1:standard trigger mode 2:trigger pulse width mode<br>3:standard trigger mode (slow shutter) |
| 6  | SCAN       |   | Partial scan selection (1bit) OFF: 38fps ON: 73fps                                                           |
| 7  | NC         |   | Not assigned                                                                                                 |
| 8  | NC         |   | Not assigned                                                                                                 |
| 9  | 10bit/8bit |   | RAW 8Bit/10Bit selection (1bit) OFF: 8bit ON:10bit                                                           |
| 10 | IN/OUT     |   | HD/VD Input, Output selection (1bit) Hirose 12Pins Circular type connector( 6,7pin )                         |

#### 7.1.1. Shutter Speed Settings (Rear panel SW1: E0, SW2: E1, SW2: E2)

##### (1) Standard scan mode (Internal sync. • External sync.)

( Standard scan mode )					( Partial scan mode )				
E0 1	E1 2	E2 3	Shutter speed	Real time	E0 1	E1 2	E2 3	Shutter speed	Real time
OFF	OFF	OFF	OFF (1/38) sec	26.54 ms	OFF	OFF	OFF	OFF (1/73) sec	13.67 ms
ON	OFF	OFF	1/76 sec	13.26 ms	ON	OFF	OFF	1/76 sec	13.26 ms
OFF	ON	OFF	1/114 sec	8.84 ms	OFF	ON	OFF	1/114 sec	8.84 ms
ON	ON	OFF	1/152 sec	6.63 ms	ON	ON	OFF	1/152 sec	6.63 ms
OFF	OFF	ON	1/500 sec	2.00 ms	OFF	OFF	ON	1/500 sec	2.00 ms
ON	OFF	ON	1/1000 sec	1.01 ms	ON	OFF	ON	1/1000 sec	1.01 ms
OFF	ON	ON	1/5000 sec	0.19 ms	OFF	ON	ON	1/5000 sec	0.19 ms
ON	ON	ON	1/10000 sec	0.09 ms	ON	ON	ON	1/10000 sec	0.09 ms

##### (2) Standard trigger mode

( Standard scan mode )					( Partial scan mode )				
E0 1	E1 2	E2 3	Shutter speed	Real time	E0 1	E1 2	E2 3	Shutter speed	Real time
OFF	OFF	OFF	1/38 sec	26.54 ms	OFF	OFF	OFF	1/73 sec	13.67 ms
ON	OFF	OFF	1/76 sec	13.26 ms	ON	OFF	OFF	1/76 sec	13.26 ms
OFF	ON	OFF	1/114 sec	8.84 ms	OFF	ON	OFF	1/114 sec	8.84 ms
ON	ON	OFF	1/152 sec	6.63 ms	ON	ON	OFF	1/152 sec	6.63 ms
OFF	OFF	ON	1/500 sec	2.00 ms	OFF	OFF	ON	1/500 sec	2.00 ms
ON	OFF	ON	1/1000 sec	1.01 ms	ON	OFF	ON	1/1000 sec	1.01 ms
OFF	ON	ON	1/5000 sec	0.19 ms	OFF	ON	ON	1/5000 sec	0.19 ms
ON	ON	ON	1/10000 sec	0.09 ms	ON	ON	ON	1/10000 sec	0.09 ms

(3) Standard trigger mode (Slow shutter)

( Standard scan mode )

E0 1	E1 2	E2 3	Shutter speed	Real time
OFF	OFF	OFF	1/38 sec	26.54 ms
ON	OFF	OFF	1/19 sec	53.02 ms
OFF	ON	OFF	1/9.5 sec	106.04 ms
ON	ON	OFF	1/4.75 sec	212.08 ms
OFF	OFF	ON	1/2.375 sec	424.16 ms
ON	OFF	ON	1/38 sec	26.54 ms
OFF	ON	ON	1/38 sec	26.54 ms
ON	ON	ON	1/38 sec	26.54 ms

( Partial scan mode )

E0 1	E1 2	E2 3	Shutter speed	Real time
OFF	OFF	OFF	1/73 sec	13.67 ms
ON	OFF	OFF	1/ 36.5 sec	27.34 ms
OFF	ON	OFF	1/ 18.25 sec	54.68 ms
ON	ON	OFF	1/9.125 sec	109.36 ms
OFF	OFF	ON	1/4.563 sec	218.72 ms
ON	OFF	ON	1/ 73 sec	13.67 ms
OFF	ON	ON	1/ 73 sec	13.67 ms
ON	ON	ON	1/ 73 sec	13.67 ms

(4) Pulse width trigger mode

In this trigger mode, shutter speed is set by the trigger pulse width.

The trigger pulse width must be set within 1H to 1/2 sec.

1HD step fine shutter speed setting is available.

The following formula can be used to calculate approximate exposure time.

$$\text{exposure time} = \text{trigger pulse width (nHD)} + 12.43\mu\text{s} \quad (\text{HD} = 24.86\mu\text{s})$$

Be sure to input HD sync signal, otherwise both 1HD of exposure starting point and the exposure time will be fluctuated by 1HD if a jitter occurs between trigger input and internal sync.

7.1.2. Operation Mode Settings (Rear panel SW4: MODE0, SW5: MODE1)

MODE0	MODE1	Setting mode
OFF	OFF	Standard mode ( Internal sync. )
ON	OFF	Standard trigger mode
OFF	ON	Trigger pulse width mode
ON	ON	Standard trigger mode (Slow shutter)

Function table

Function	Standard mode	Standard trigger mode	Trigger pulse width mode	Standard trigger mode (Slow shutter)
Fixed shutter speeds			× 1	
Partial scan mode				
External sync.	HD/VD	HD	HD	HD

1 The shutter speed equals to the trigger pulse width.

Standard mode

Standard mode means progressive scan, 38fps, and invalid trigger shutter.

In the standard mode and partial scan mode, external HD/VD sync input can be operated.

Standard trigger mode/Standard trigger mode (Slow shutter)

In these modes, the shutter speeds are controlled by the fixed switches on the rear panel.

HD sync input is enabled.

Jitter between Int. HD and Trigger will cause 1HD fluctuation in exposure time.

To avoid this fluctuation, please synchronize with EXT. HD. Note that the trigger pulse width must be over 1 HD.

### 7.1.3. Partial Scan Setting Switch (Rear Panel SW: 6 SCAN)

SCAN	Scanning mode	V Scanning lines	Rate	V Effective lines
OFF	Full pixels	1068 Lines	38 fps	1024 Lines
ON	Partial scan mode	550 Lines	73 fps	258 Lines

Partial scan is the mode, which increases the frame rate by reducing the number of read-out vertical lines.

The upper part and the lower part of the image are omitted, and only the central portion of the vertical lines is read out. When gain is set at over +6dB, V shading may become visible.

V-Shading portion can be deleted by setting data "1" to address 057 which eliminates the top 35 lines.

Effective lines setting and readout position in partial scan mode

(1) In partial scan mode, effective lines and readout position can be set with remote control.

(a) Effective lines setting: By setting address 049, 255 line to 681 line can be set per 3 lines steps.

Address 049 Set value	Effective lines	TOTAL Lines (Address 052&053:Read only )	Frame Rate
0	255	548	73fps
1	258	550	73fps
⋮	⋮	⋮	⋮
⋮	⋮	⋮	⋮
⋮	⋮	⋮	⋮
142	681	832	48fps

X: min0 ~ max142	$255+3*X$	$548+2*X$
------------------	-----------	-----------

(b) Readout position setting: By setting address 051, every 3 lines steps can be set from the top.

Address 051
Min 0 ~ Max258-X (address 049)

< Setting example >

Q . Need to readout effective 600 vertical lines from the 300<sup>th</sup> line.

- A .
- (1) address 000:1⋯⋯ Remote control
  - (2) address 005:1⋯⋯ Partial SCAN mode
  - (3) address 049:115⋯⋯ Effective line setting((600-255)/3)
  - (4) address 051:100⋯⋯ Readout position setting (300/3)
  - (5) address 063:83 ⋯⋯ Data saving (If necessary)

(Camera internal SW104-2 shall be ON to save data)

(d). Partial Scan Timing

(d). Partial scan timing

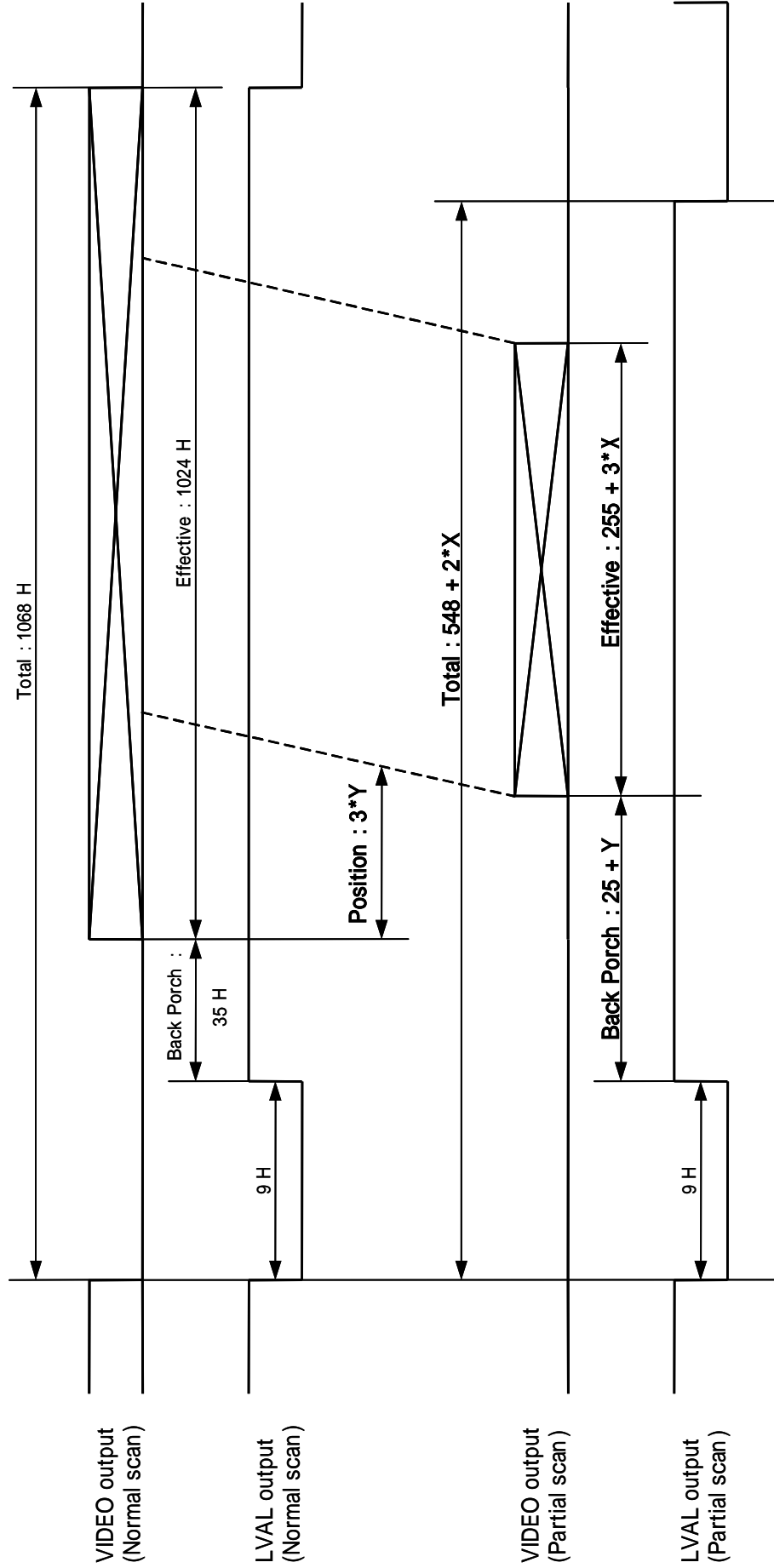

X : Address 049 Set value  
 Y : Address 051 Set value

7.1.4. (Rear Panel SW7: -)

	NC

7.1.5. (Rear Panel SW8: -)

	NC

7.1.6. 8 bit / 10bit Selection Switch (Rear Panel SW9: 8Bit/10Bit)

8bit/10bit	8 bit / 10 bit output selection
OFF	8 bit output
ON	10 bit output

7.1.7. HD / VD Input / Output Selection Switch (Rear panel SW10: IN/OUT)

IN/OUT	HD/VD Input Output selection
OFF	HD, VD output
ON	HD, VD input (Ext. Sync. mode)

This is the selection of 6pin(HD), 7pin(VD) of the circular type 12pins connector on the rear panel.

7.1.8. WEN (Write Enable) Signal Output

WEN signal is output through 10 pin of circular connector when video signal is output in the trigger mode. By setting the data of address 055, WEN signal format can be changed.

- Data : 0 . . . single pulse VD (9H pulse width) (initial setting)
- : 1 . . . FVAL (Frame enable)
- : 2 . . . Exposure
- : 3 . . . not assigned

\* By adjusting the phase, the necessary amount of illumination can be reduced, incoming light overexposure time can be eliminated, and consequently, amount of smear can be reduced.

7.2. 12 Turn Rotary Potentiometer for Manual Gain Adjustment

Adjustment range : -1dB ~ max +12dB

(The performance guarantee range : 0 ~ +6dB. When Gain is set over +6dB, artifacts such as vertical stripe, beat noise, and shading may become visible.)



7.4. HD/VD Trigger Input/Output Circuit of 12pin Circular Connector

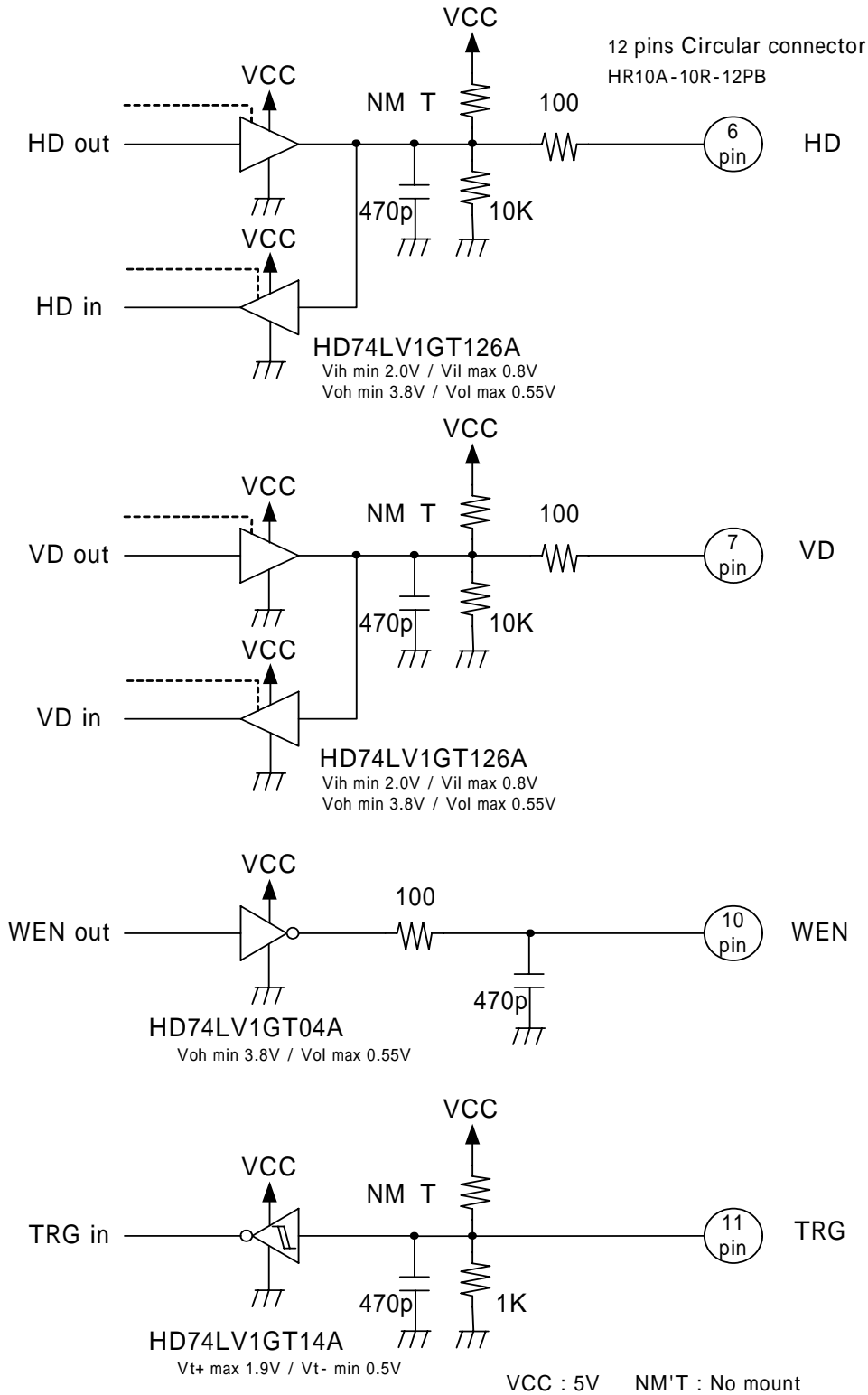

Please refer to the manufacturer's data sheets for the characteristics of component parts.

## 7.5. Remote Interface Function

Through RS-232C interface, the camera can be controlled by external PC.

(1) The settings for RS-232C are as follows.

Baud rate: 9600bps  
 Data: 8 bits  
 Stop bit: 1bit  
 Parity: None  
 XON/XOFF: Not controlled

(2) Control code

- The total control code is 14bits which conforms to ASCII code.
- The control code consists of camera No, process code, remote controller address, remote controller data, and CR. Execute Read/Write through PC, and the camera will reply the data.

1	2	3	4	5	6	7 <sup>th</sup> Byte	8	9	10	11	12	13	14
Camera No.						Process code	Remote controller address			Remote controller data			CR
00000: Common to the all cameras						"R" Read mode	Refer to the address table of 5.4 function setting			000 ~ 255			0 Dh
000001 ~ ZZZZZZ: Camera No of individual camera						"W" Write mode							
						"C" Camera mode							

Camera No shall consist of 6 bytes of characters/numeric strings. Send the individual camera number code or common number code, "000000". The reply data from the camera shall contain the registered number for that camera.

Process code

Input any one of R, W, or C to the process code. R (read mode) is to read the data of remote controller address. Please be noted to set any dummy data (000 ~ 255) to 11<sup>th</sup> ~ 13<sup>th</sup>, since a command shall consist of 14 bytes.

W (write mode) is to write the data to the remote controller address. Please be noted that the data cannot be saved into EEPROM of the camera. (Reboot the camera, and the data is reset to the initial setting.) To save the data into EEPROM, set camera internal switch, SW104-2, ON, and send the save data, "83", into the address 064.

**Note; Once the data was saved into EEPROM, it may not be reset to the initial settings.**

C is the code to send the data back from the camera.

**Note; Do not set code C when sending the data from PC side.**

Remote controller address

**Note; Do not save the data into the address other than specified, since it may cause the damages or malfunction of the camera.**

Remote controller data

Set the decimal number (000 ~ 255) for the remote controller data. Please be noted to set any dummy data in read control mode.

CR

Be sure to input "CR" to confirm the end of the command.

### (3) Setting Example

Set Gain to +6dB with remote control function.

Step 1 Set the camera to "000000"(assign the common camera number).  
Write "1" into address "000" to set the camera into remote control mode.  
Please be noted that the camera control switch becomes invalid in remote control mode.

Code from the PC: "000000W000001CR"

Step 2 Set Gain to +6dB.

Code from the PC: "000000W001002CR"

## 8. Safety/Quality Standards

- UL Standard  
Conform to UL Standard including materials and others.
- CE Marking (to be acquired)  
Conform to EN50081-2 ( Emission )  
Conform to EN50082-2 ( Immunity )
- RoHS  
Conform to RoHS restricted items.

## 9. Durability

Item	Specification	Remarks
Vibration resistance	Acceleration            7.0 m/s <sup>2</sup> Vibration frequency    11 ~ 200 Hz Sweep interval            300 sec Direction                    XYZ 3 directions Testing time                10 min for each direction  No malfunction shall occur after testing the above.	
Shock resistance	Acceleration            490 m/s <sup>2</sup> (50G) Direction                    6 direction	Without package
Operation temperature	-5 ~ +45    with RH 20 ~ 80% (No condensation) a) Leave the camera for 1 hour at the highest operation temperature (no condensation), turn on the power, and then the camera shall operate and meet the specifications. b) Leave the camera for 1 hour at the lowest operation temperature (no condensation), turn on the power, and then the camera shall operate and meet the specifications.	

## 10. Timing Chart

### 10.1. Horizontal Synchronous Signal Timing

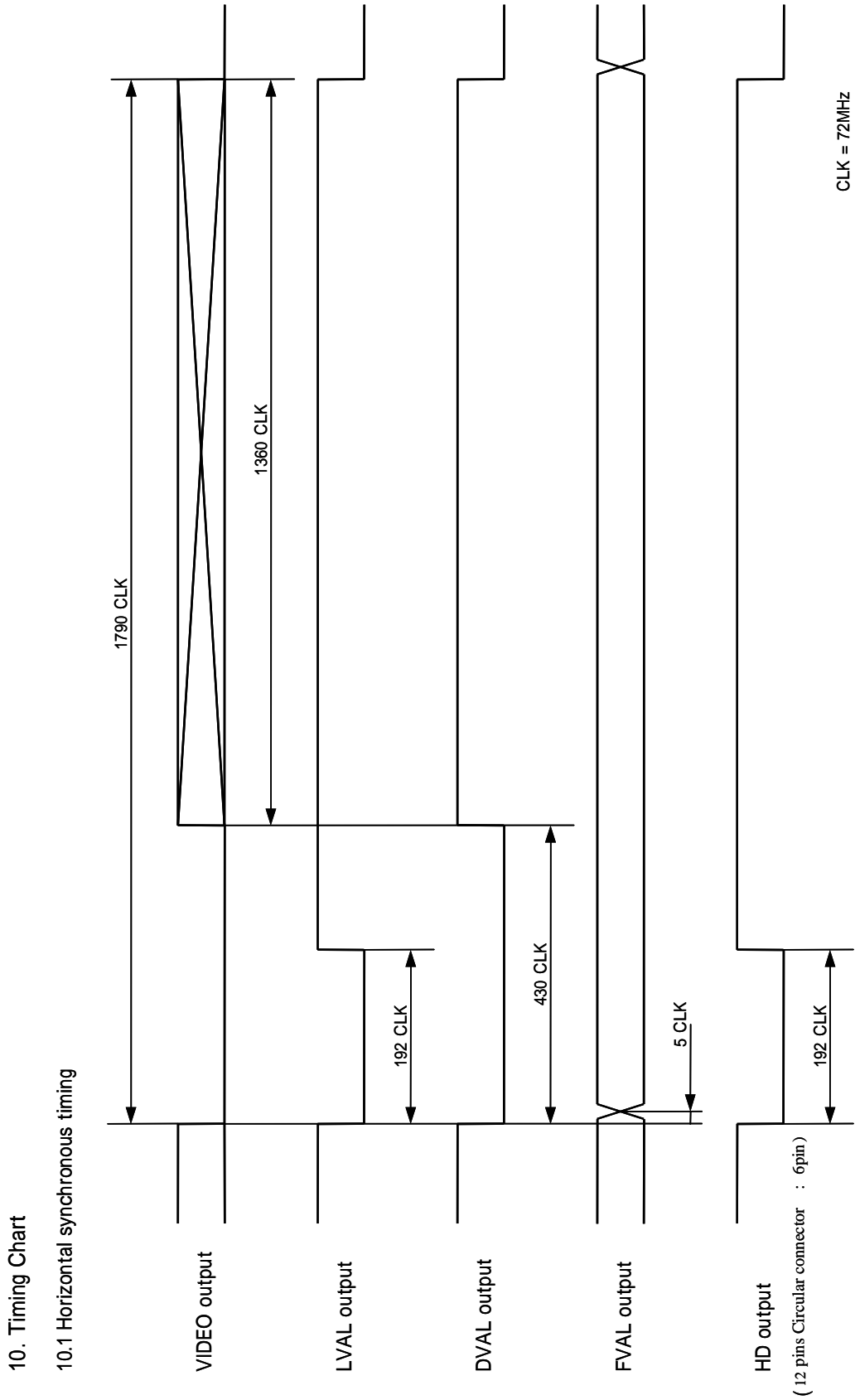

## 10.2. Vertical Synchronous Timing

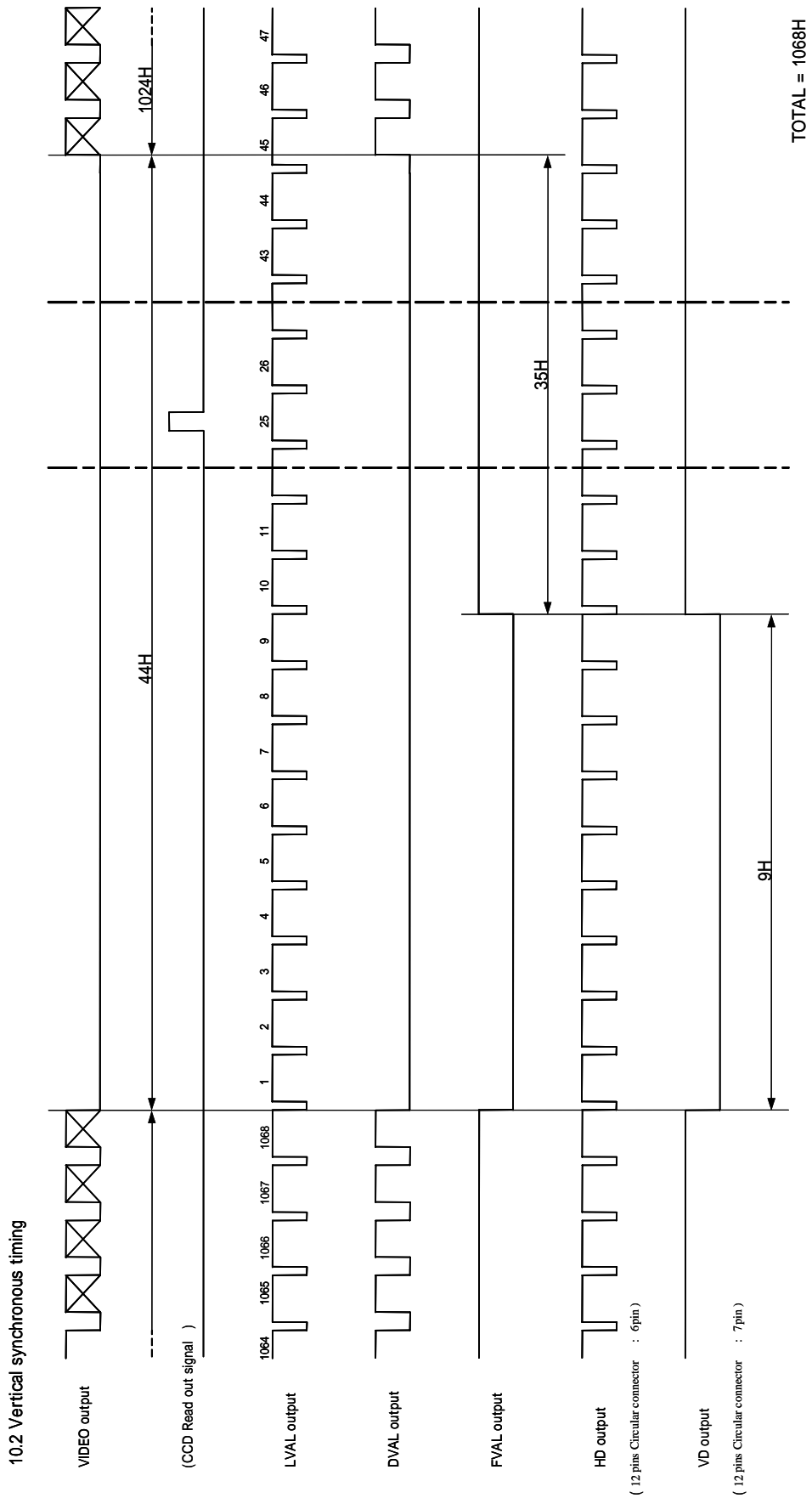

### 10.3. Vertical Synchronous Timing (73 fps Partial Scan Mode)

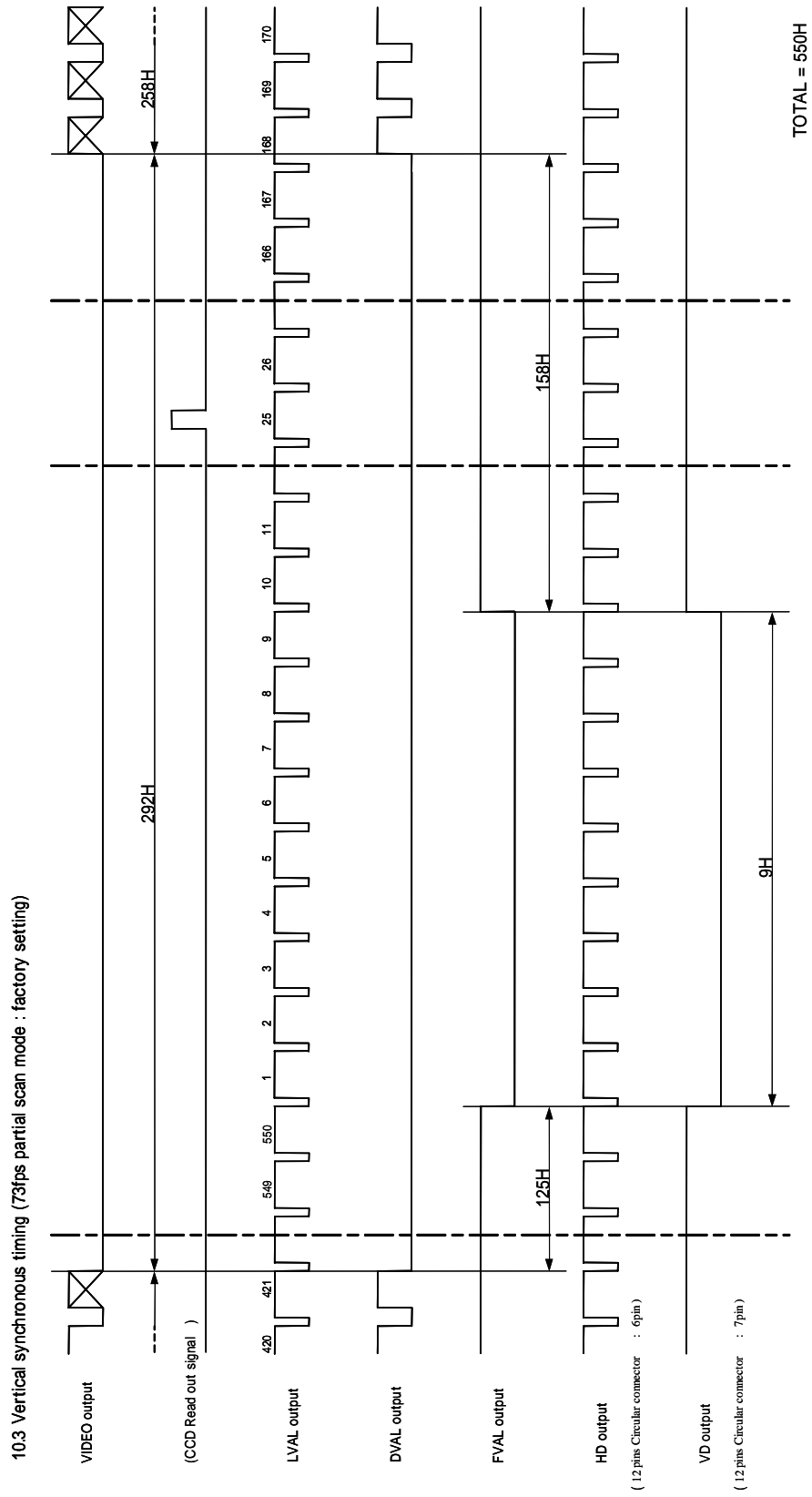

## 10.4. Standard Trigger Timing

10.4 Standard trigger timing

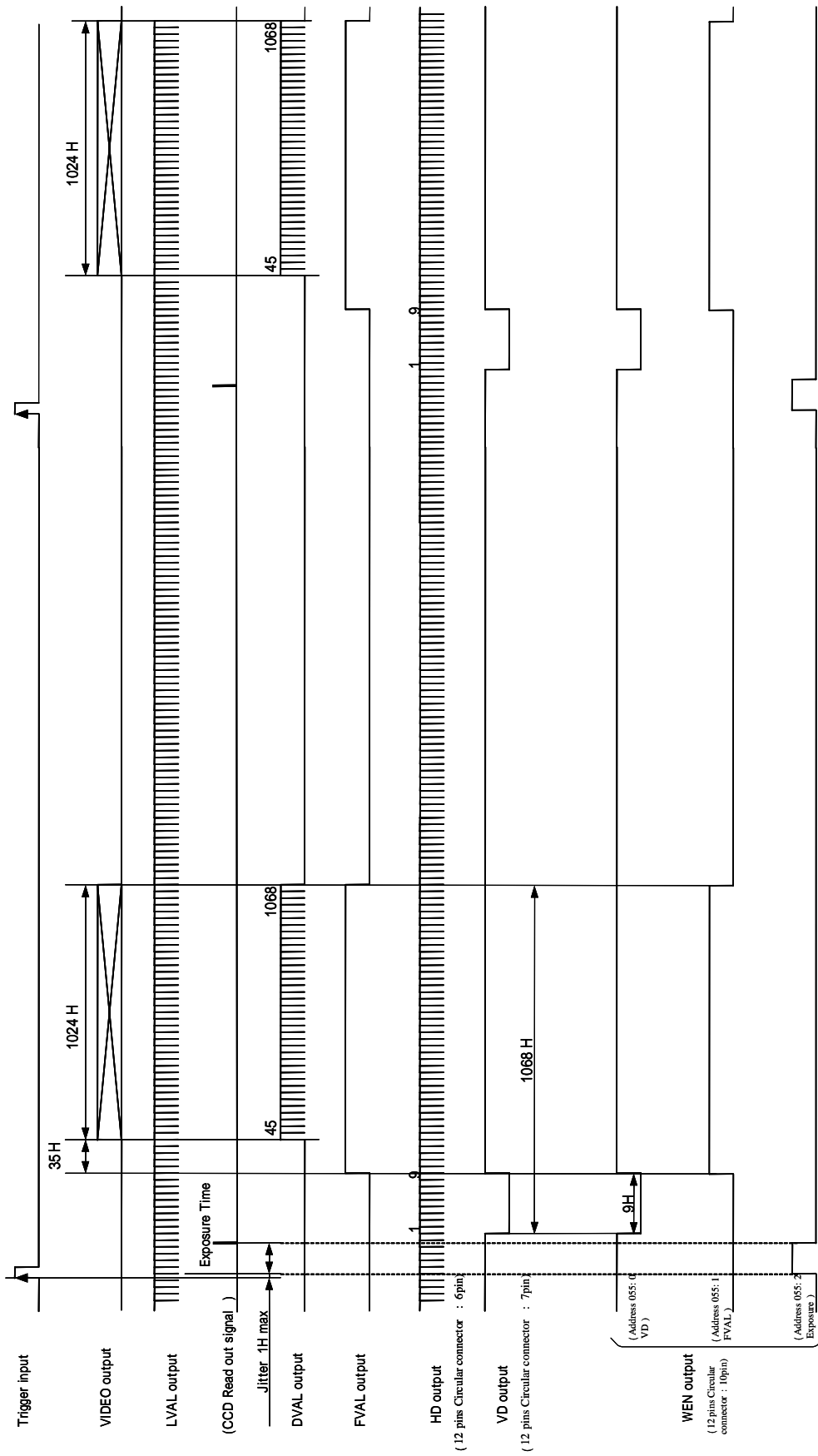

## 10.5. Pulse Width Trigger Timing

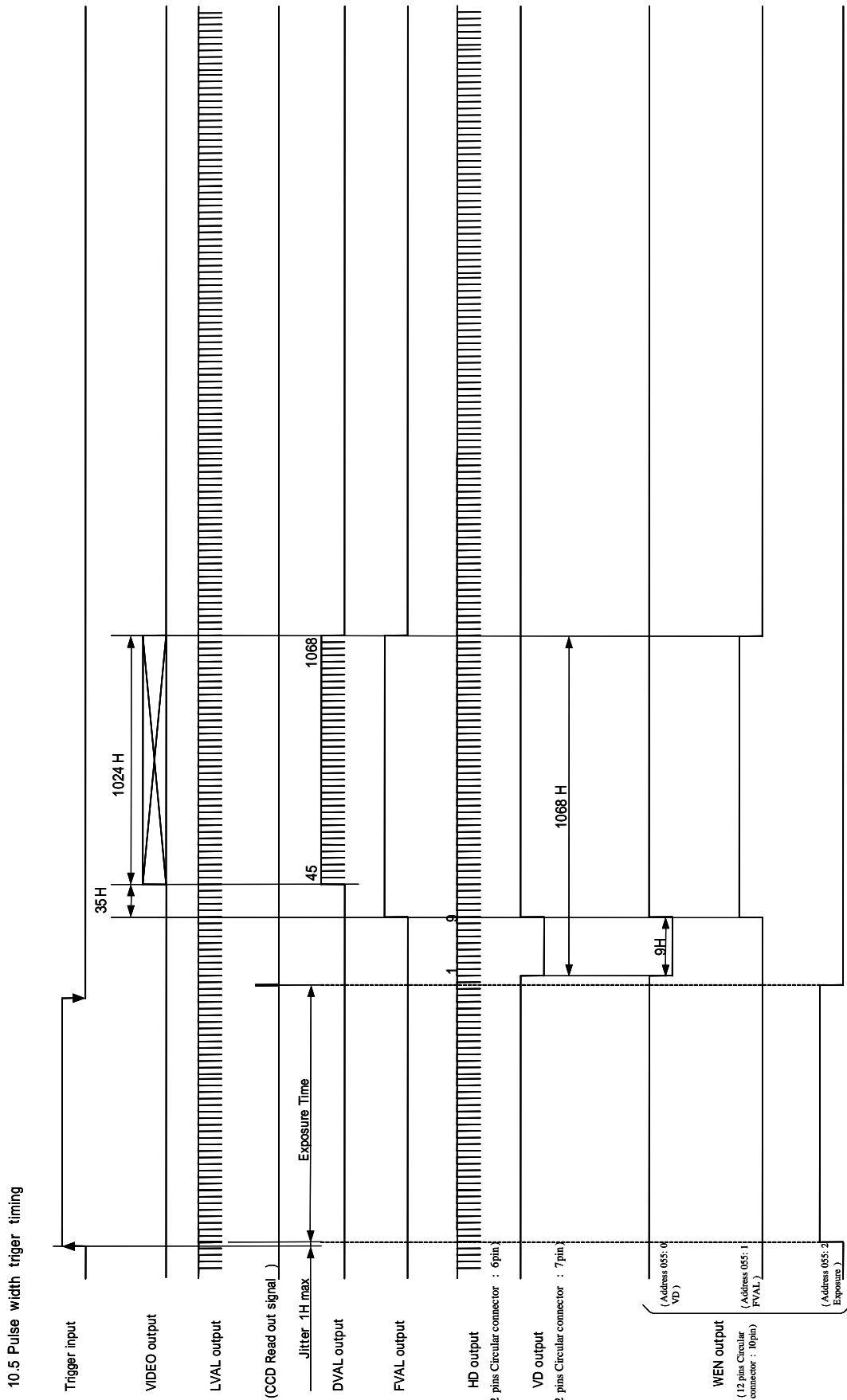

11. Dimensions

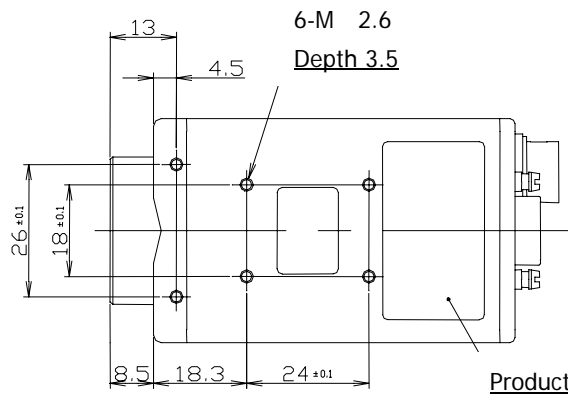
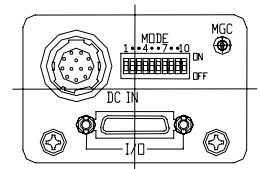
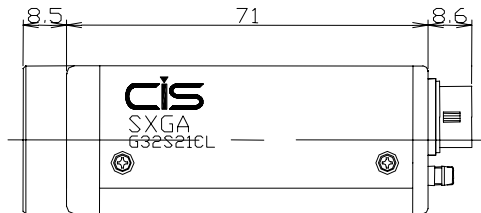
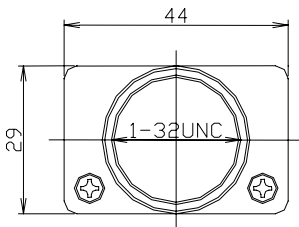
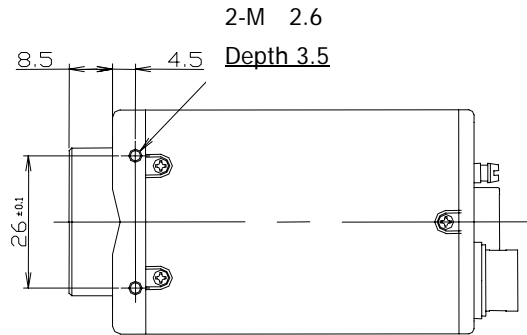

999-421-00-00

## 12. Cases for Indemnity (Limited Warranty)

We shall be exempted from taking responsibility and held harmless for damage or losses incurred by the user in the following cases.

- In case damage or losses are caused by fire, earthquake, or other acts of God, acts by third party, deliberate or accidental misuse by the user, or use under extreme operating conditions.
- In case indirect, additional, consequential damages (loss of business interests, suspension of business activities) are incurred as result of malfunction or non-function of the equipment, we shall be exempted from responsibility for such damages.
- In case damage or losses are caused by failure to observe the information contained in the instructions in this product specification & operation manual.
- In case damage or losses are caused by use contrary to the instructions in this product specification & operation manual.
- In case damage or losses are caused by malfunction or other problems resulting from use of equipment or software that is not specified.
- In case damage or losses are caused by repair or modification conducted by the customer or any unauthorized third party (such as an unauthorized service representative).
- Expenses we bear on this product shall be limited to the individual price of the product.

## 13. Handling Precautions

**【Important】** Please observe all warnings and cautions stated below.

Our warranty does not apply to damages or malfunctions caused by neglecting these precautions.

- Do not use or store the camera in the following extreme conditions:
  - Extremely dusty or humid places.
  - Extremely hot or cold places (operating temperature  $-5$  to  $+45$  )
  - Close to generators of powerful electromagnetic radiation such as radio or TV transmitters.
  - Places subject to fluorescent light reflections.
  - Places subject to unstable (flickering, etc.) lighting conditions.
  - Places subject to strong vibration.
- Remove dust or dirt on the surface of the lens with a blower.
- Do not apply excessive force or static electricity that could damage the camera.
- Do not shoot direct images that are extremely bright (e.g., light source, sun, etc.), and when camera is not in use, put the lens cap on.
- Follow the instructions in Chapter 6, "External connector pin assignment" for connecting the camera. Improper connection may cause damages not only to the camera but also to the connected devices.
- Confirm the mutual ground potential carefully and then connect the camera to monitors or computers. AC leaks from the connected devices may cause damages or destroy the camera.
- Do not apply excessive voltage. (Use only the specified voltage.) Unstable or improper power supply voltage may cause damages or malfunction of the camera.
- Make sure that the camera and peripheral equipments are properly connected before turning the camera on. Especially in INT/EXT sync signal settings, improper connection may cause damages to the camera and the connected devices.
- VCC-G32S21CL can be connected to a capture board for Camera Link by use of dedicated cable.
- In case of abnormal operation, contact the distributor from whom you purchased the product.